

radio control MODEL CARS

ISSUE No. 7

SIX ISSUES PER ANNUM

Price 50p. \$1.50 (US) DM3.50

Fr. F6.00 Gir.3.50 Sw. Fr.3.00

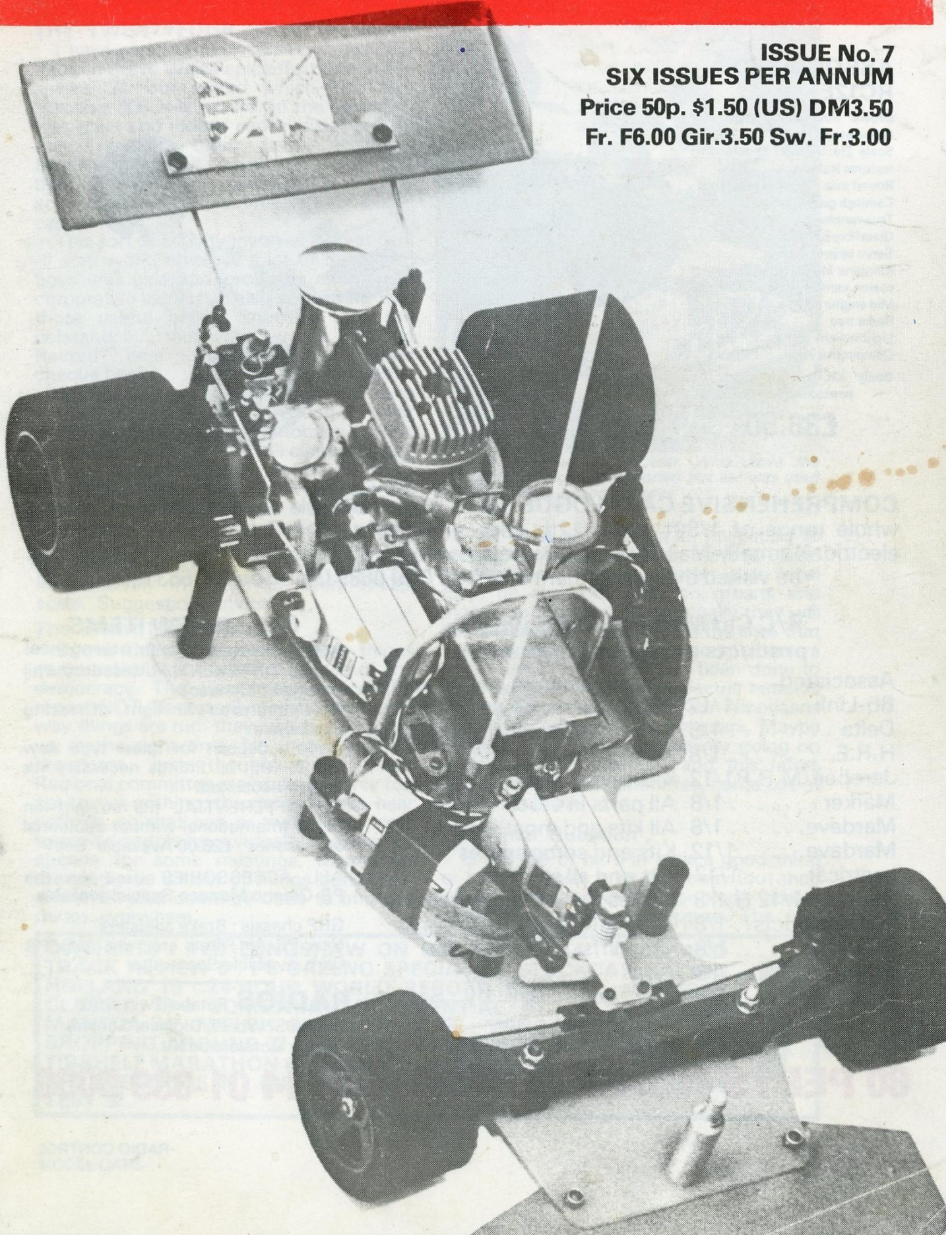

R/C CARS

**Ted Longshaw for
Service & Experience**

ASSOCIATED RC12E

Orders now being taken for Associated's great new 1/12th Scale Electric car. Outstanding features include:

- Round axle — precision ground
- Camlock gear mesh adjustment
- True running silent gears
- Glassfibre chassis
- Servo saver
- Kingpins inside wheels, correct caster, camber, toein, ackerman.
- Mid engine design
- Radio tray
- Light weight
- Competitive Price

Basic kit unassembled (no motor or resistor)

£38.50

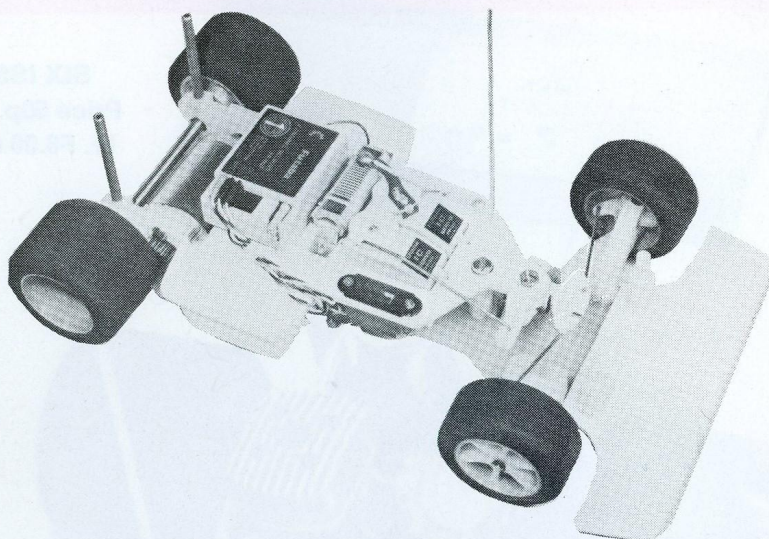

COMPREHENSIVE CATALOGUE (Send 50p refundable on first purchase) covers whole range of 1/8th and 1/12th cars, engines, accessories, kits, glowplug and electric. Normally Mail Order only we also have a showroom near Biggin Hill that can be visited by appointment any time (Tel 0689 (London 66) 55313)

R/C Car Manufacturers whose products are normally ex stock:

- | | |
|--------------------------|--------------------------------------|
| Associated | Complete range and all spares |
| Bo-Link 1/12 | Complete range and all spares |
| Delta 1/8 | Complete range and all spares |
| H.R.E. 1/8 | Kit by Chuck Hallum |
| Jerobee/M.R.P1/12 | Kits and spares |
| Marker 1/8 | All parts in stock |
| Mardave 1/8 | All kits and most spares |
| Mardave 1/12 | Kits and some spares |
| Lectricar 1/12 | Kits and all spares |
| Parma . . 1/12 & 1/8 | Bodies and other goodies |
| P.B. Products . . 1/8 | Complete range and spares |
| Thorp 1/8 | Kits, diffs. and all spares |
| Ultimara 1/8 | Tyres |
| S.G. Italy 1/8 | The latest kit by Sabbo the Futura 3 |
| U.F.R.A. 1/8 | Very special Swiss tyres |

OTHER NEW ITEMS

Differentials are in with a vengeance! AMPS DIFFERENTIAL (used by Phil Greeno at Monaco)

Now improved in light of racing experience

Place a deposit for latest type now. **£49.95** with all fittings necessary for PB or Associated.

PB DIFFERENTIAL fits straight on to PB International without additional accessories. **£28.00** Available Sept

ALL ACCESSORIES used on the PB-Greeno Monaco Special available

GRP chassis : Brake adjusters
New PB Air Filters etc., etc. New PB Carb, available September

RADIOS Futaba Twin-Stick,
Futaba S/Wheel, Digiace, Sanwa,
Trigger Conversion Kit.

80 PEPYS ROAD, LONDON SE14 01-639 5080

radio control

MODEL CARS

Published by L-D EDITORIAL — TECHNICAL SERVICES LTD., P.O. Box 30, HEMEL HEMPSTEAD, HERTS. HP1 1NL. SEPTEMBER 1978.

Editor: "Dickie"
Laidlaw-Dickson

THE TWENTYFOUR HOUR RECORD

I have given quite a splash to the Paul Padgin/Steve White epic effort to achieve a new 24-hour record which also embraced a 500 mile record. In the between-war years and indeed earlier distance and time records, often using the old Brooklands circuit, were very much the thing, with people like George Eyston achieving phenomenal times in the fullsize car world.

This sort of activity involves a great deal of staff work, employs a lot of backroom boys and girls and produces a splendid corporative spirit. It is also something that those useful people sponsors can understand. . . the very words "World Record" gets them reaching for their cheque books. . . Guinness here we come.

Are there any other activities that have yet to be explored? In talking to that AMPS man Ian Agnew at Monaco he was visualising some form of hill climb or cross country driving that could fit into our scale of things. One or two of the old slot car clubs built up hill climbs as a sideline — I think Northampton had a devilish one with a 2 1/2/1 section, escape roads, return road, the lot. Could such a climb be made up inexpensively in 1/8th or even 1/12th scale. Suggestions invited. . .

The Silent Majority. . .

One of the problems of running things democratically is the awful silence of the democracy. The silent majority are not, repeat NOT, necessarily satisfied with the way things are run, they just do not speak up at the right time. No, not a political broadcast, just thoughts on EFRA. Regional committee members are only too apt to say nothing, the national reps hear nothing, so that one or two rather more farseeing people have virtually to invent an agenda for some meetings. Meanwhile there may be a host of things both great and small that could be done to improve things everywhere.

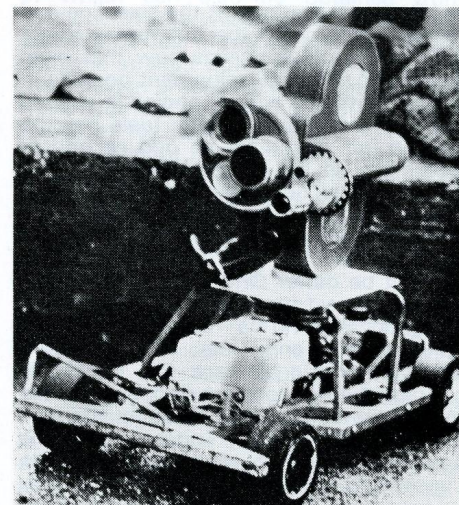

Camera mounted on stockcar. Who drove the precious Arriflex is not reported but car was used for TV closeup action pictures.

This must be taken as an invitation to moan about shortcomings; think up good constructive notions; pester your local man; he can then pass on groans and moans up the line and eventually they will be discussed at top level. On the lines that "justice must be seen to be done" I have a moan that far too little has been done to get a proper 1/12th scale electric national car set-up going . . . yet the Americans have been going strong for years. Maybe there is a great burst of activity going on underground but please, and this refers also to that BRCA committee, come out of hiding and talk.

The Nitro Question . . .

Is the use of nitro in fuels a good thing or bad? It costs a lot of money (but then so do tyres) and will undoubtedly cost a great deal more in the future. The per-

CONTENTS : TED LONGSHAW ON GENEVA 1979 4 : CLUB AND TRACK REVIEW 5 : PB-GREENO SPECIAL 7 : STOCKCAR RACING HOLLAND 10 : 24-HOUR WORLD RECORD RUNS 12 : CATFOSS CLASSIC 18 : SOMETHING DIFFERENTIAL PT.2 22 : MAKING MANTUA 24 : WELSH GRAND PRIX 27 : WING AEROFOILS 30 : SHOPPING AROUND 32 : LETTERS 34 : ELECTRIC R/C RACING 40 : TIBSHELF MARATHON 42 : STOCK CAR NOTES 44 : FIRST STEPS IN R/C ELECTRICS 48 : MORE ELECTRICS 51 : K & B 3.5 cc. ENGINE TEST 52.

7

centages used vary enormously from a modest 5% to a generous 50%. Would some of our top drivers be anything like so good without it? Most people know that it can be dangerous to inhale it and minor accidents have happened with mechanics holding cars overlong at the start line and being overcome by the hot fumes rising. Cars are reaching speeds now that must be the top line of development possible in the capacity and type of engine in use, so that more and more exotic fuels may be tried in the search for an odd second or two a lap. Is this a good thing? Should steps be taken now (as in some sections of the model aircraft world) to decide what fuel may be used by competition drivers?

This raises the next question — how could it be done? One method would be for the contest organisers to issue fuel to entrants, making a suitable financial adjustment to entry fees. With a limited amount per car per race this could encourage better consumption figures but might be a tedious extra chore for the host circuit. Alternatively, nitro could be banned altogether and cars random checked at meetings with a fairly simple

litmus-paper kind of test. This would be an all or nothing arrangement — like drugs it is either there or not there.

Anything on these lines would have to be promulgated by EFRA in good time so that a new generation of engines (without nitro addiction) could be introduced and drivers have time to learn any new techniques. Here is just another of those questions that could be conveniently raised and discussed by clubs and their views put forward.

World Champs at Geneva

Ted Longshaw has some words to say about next year's Geneva meeting in this issue. It should be a magnificent event, it wants an enormous amount of pre-race effort, and the keen early expression of interest by would-be entrants will be a great help. Again, speak up drivers all over the world. We know the South Africans have some good men, we've seen them, what about the growing band of enthusiasts in Australia and New Zealand — can they manage to get over . . . won't some kind sponsor (Foster's Beer?) send over a team?



TED LONGSHAW TALKING

1978 SWISS EFRA MEETING: GENEVA

This year's meeting was held on the circuit that will be used next year for the official R/C World Championship. Keith Plested and myself therefore had more than just a pleasant weekend's racing in mind when we decided to take part.

For Keith it was an opportunity to demonstrate again that his Monaco result was no fluke, he really is fast these days, and he proved it with FTD both days. Udo Franke managed to peg Keith and I back to 2nd and 3rd on Sunday, but then it is no disgrace to be beaten by Euro-Champion in his own country! For me it was an opportunity (with EFRA President hat on) to gain impressions of what awaits us next year, as well as enjoying the hospitality and friendliness of the Swiss racing scene.

Without doubt we have no need to worry about the organisation side, the City of Geneva has promised full support and

NEXT YEAR AT GENEVA

help to the club, and they seem very enthusiastic towards the hobby.

The track is adjacent to an indoor and outdoor swimming pool and restaurant, and is within ten minutes walk of the Town Centre. So wives, mechanics, children etc should be content. The surface is typical car park asphalt, reasonably smooth with the "bite" coming in the more it's used. Keith's fastest one lap time was around 22 secs., but I'm sure that with more grip the Gheris and Jianas of this world will be looking for 20 secs (about 36 mph) I have no doubt the American contingent will feel at home on the circuit (but equally I have no doubt they're going to find winning a bit more difficult than they did in Pomona)

So why am I still a bit worried about this event?

(1) **Entries!** How many non-Europeans are thinking of coming? Neither the Geneva Club nor EFRA have any real idea. How about it ROAR, South Africa, Australia etc etc. Could you let us know a rough idea of how many are likely to come. There are tentative plans to cater

CLUB & TRACK REVIEW

Woodspring Radio Auto Club

Secretary: Richard Beckett
GB Models, 9 Thornbury Road
Uphill, Weston-super-Mare. Avon.

Woodspring are staging an extra event, not on the calendar, which will provide exciting spectator entertainment with even more exciting participation on the Sunday of the autumn Modellers Holiday Week at nearby Brea Sands which runs from 7th to 14th October. On Sunday 8th October they are staging a Four Hour Team Race for Sports/GT cars. Entry will be limited to ten teams and pre-booking is essential (in the rare event of there not being a full quota I imagine it might be just possible to squeeze in — but don't bank on it!). A novel feature will be the introduction of a Le Mans start. Cars will be on one side of the track and on the fall of the flag teams will race over to start their cars as fast as they can. Racing will begin at 12 o'clock sharp, late enough to give travelling team a chance to get there, and for holiday makers to have a Sunday lie-in! Pontins National Manager Bob Chapple has been instrumental in obtaining support from the well known West country cider firm Bulmers who will be presenting the "Bulmer Trophy" to the winning team. . . there will naturally be other useful awards. Racing managers, club secretaries or potential team managers should drop an immediate line to Richard Beckett for detailed rules and entry forms.

for 150-200 maximum drivers over five days of racing. This is assuming that we somehow limit the Euro-entry to around one hundred (another problem for EFRA) Can anyone think of a way to classify drivers worldwide?

(2) **Expense** Make no mistake the exchange rate for the Swiss Franc is favourable to no-one except the Swiss. You no doubt know your own country's exchange rate for the Swiss franc and I'll tell you that a trackside beer or coke will cost you two of them. Regarding accommodation, there will be free dormitory type beds for drivers, but the close proximity of the French border means that a twin-bedded room can be had fifteen minutes drive from the circuit for 60/80 French Francs.

Whatever the problems I am sure all the world's top drivers will be there. The Europeans with their tails up after Monaco, the Americans thirsting for revenge and the rest of the world an interesting unknown quantity. Please let us know if you're thinking of coming. T.L.

The circuit will be open I understand for use during the whole of the Modellers Holiday Week 7th-14th October, details of which can also be obtained from Richard. Drivers will be relieved to know that a great deal of track work is going on, with the straight bumps now ironed out, the infield in process of being grassed and those horrible stones that got flung up things of the past.

Last thought on that team race: Entry Fee is £5 per team; each team to number not less than four persons and not more than six, so no chance of being captain, crew and cabin boy of a one-man team!

Aberdeen Radio Car Club

Secretary: Ray Cowie
34 Thorngrove Avenue Aberdeen.

A hearty welcome to another club in Scotland! Aberdeen Club has been in existence now for over four months and membership is over the forty mark growing at the rate of about two members per week. At the moment two large car park areas are in use, one with track marked out on it. The Committee spent a very enjoyable two days at the British Nationals at Wombwell, and would like to say thanks to Fred Livesey and Nigel Heighton for answering the endless flood of questions put to them. Visitors to the Granite City will be most welcome to join the merry band if they drop a line to secretary Ray Cowie.

Aylesbury Electric Car Club

Secretary: Bill Burkinshaw
14 Mowbray Road (Aylesbury 21676)
Aylesbury. Bucks

Bill Burkinshaw reports encouraging nucleus of members who meet every other Thursday to race on a smooth tarmac school playground, with high hopes of working up to a school hall for the winter months. New members and visitors welcome — asphalt is so much kinder to beginners and the experts can go flat out all the time (as if they didn't anyway!)

London Radio Control Car Club

Another club newsletter to make the wheels go round faster emanates from club sec. Bob Rosser in the shape of **Wheel Spiel** which combines useful info with some degree of incitement to naughty things . . . fancy suggesting that a suitable "Hunt the Shunt" should be encouraged to wreak havoc amongst the experts . . . as if we didn't have enough of them like weeds without watering them . . . anyway all light hearted stuff.

Programme so far has produced one well known winner (guess who? initials PG) chased home by the fast improving Pat Angelin. Event scheduled for July 30th when experts would be seeking their form at Lilford and hence for the "rabbits" to show their paces produced a wet day until the afternoon, some exciting pile-ups and no sign to speak of rabbitry amongst the contestants. July 30th Greeno F/1 Trophy won by Ron Ellis, 2 Ted Longshaw, 3 Jim Moon, 4 Bob Rosser, 5 Doug Blair, 6 Mike Wickens. Sec Bob Rosser's new address: 17 Hapgood Close, Greenford, Mx (01-864-7313).

Ally Pally Electric Car Club

A special meeting to approve a proper club constitution produced same without any wild changes. Useful rule is the discretionary one that full members shall attend at least 30% of meetings in any three month period under risk of losing their membership. With a waiting list at the gate this seems a very fair deal. Spring championship went to Tim Sowter who enjoyed Ted Longshaw's sponsorship. Apart from the skill of winning by a comfortable margin against a field of point winning contestant fifteen deep plus the others who did not score anything it is interesting to see what Tim ran: Jerobee grey nylon chassis with full length Kydex plate; Mabuchi RS54 (Redspot) motor; Smoothtronic speed controller with added voltage regulator; Bolink grabber rear tyres, plastic hubs; Bolink hugger, front tyres, plastic hubs. Model flight servosaver with Akermann steering, Datsun Z car painted body with rear aerofoil by Bolink, Futaba Radio gear and steering servo. General Electric NiCads. This brings up a thought that there are

now a number of rewinds going round and a general hotting up of motors that needs to be watched. As when and if said reworked jobs fail there is a high risk that they may injure other more expensive equipment on the car. Any untoward slowing up of a vehicle should be regarded seriously and battery disconnected until the trouble found. Several speed controllers have been damaged this way — so watch any unexpected attacks of "the slows".

Racing in Portugal

Report of first meeting at the Estoril Circuit is of special interest. The event as open to Formula and Sports/GT with six entries in each class (not bad for a start as secretary says) Races took the form of three mains each of fifteen laps with A Fernandes heading both divisions:

Formula	Sport
1. A. Fernandes	1. A. Fernandes
2. MNJ Mario	2. G. Homem
3. G. Homem	3. V. Costa
4. V. Costa	4. MNJ Mario
5. J. Oliveira	5. J. Oliveira
J. Machado	J. Machado

No details of cars, engines, or circuit . . . more next time we hope.

Radio Car Association of Tasmania

RCAT flatters the BRCA by having a club badge very like theirs. A colour photograph, alas not reproduceable shows some of their cars taken at a local Police Driver training circuit for motorcycles, track length approx. 118 ft. and 15 ft. wide. Negotiations in progress for their own circuit. Cars include the PB Double (popular still down there) (3 cars). Three modified Kyoshos. PB Expert imported from England by English owner.

PB-GREENO SPECIAL...

The Editor talks with Phil Greeno about his World Cup winning car. . .

DD: Tell me Phil what is so different about this car from the PB. . . it is initially isn't it, basically a PB?

Phil: Yes, the car is basically PB. The modifications are to the chassis which is a glass reinforced chassis; the car has also obviously an AMPS differential unit, and other small modifications which are aimed at making the car handle slightly better, and also more reliable. I fitted a Delta steering system to the steering linkage which is a Delta servo-saver with Delta ball-joints. Our own brake adjuster which fits on the disc brake unit which enables you to adjust the brake, giving you more or less brake without affecting the throttle linkage. This means you can make adjustments literally within seconds, without undoing any linkages or undoing any quick-links. Also I use our won flip-top tank which is made from a Johnson kit with an Associated flip-top, and our own removable sump. This is very reliable.

DD: How is the sump made?

Phil: The sump is in fact made from the lid of a Joy thimbers can, or a nitro can, any of those 500 millilitre cans make an excellent sump, if you cut the top off you have a removable sump . . .



Phil Greeno complete with PB-Greeno Special taken at Monaco on the eve of his win.

Below: Car (which also graces our cover) and the original Parma March F/1 body wearing surprisingly few battle scars after its hectic runs.

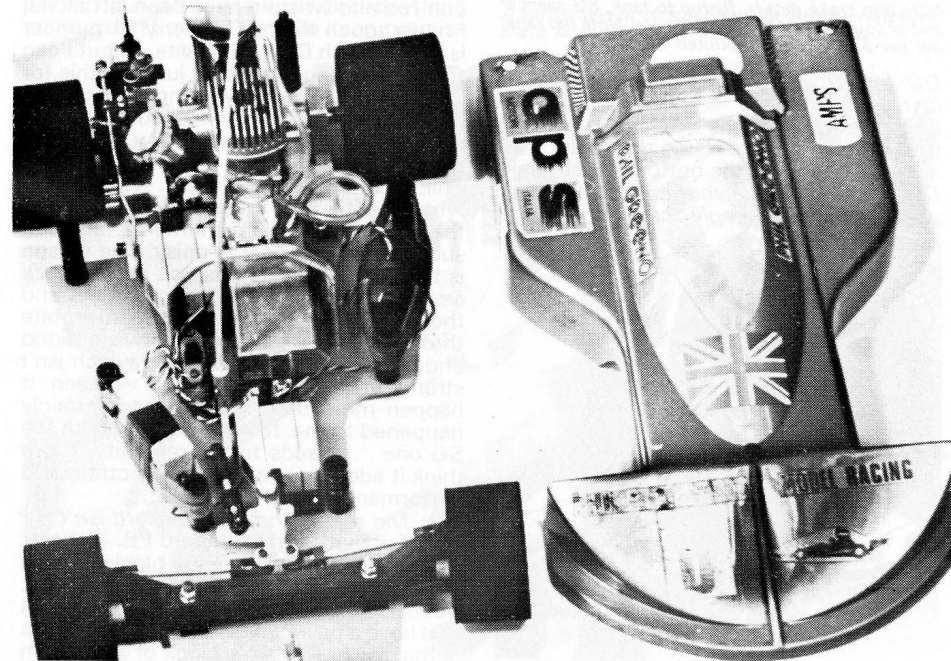

NEW FROM **parma** INTERNATIONAL INC.



TOYOTA

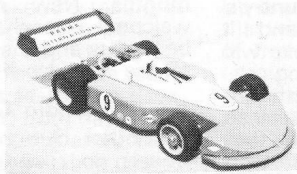

MARCH F.1

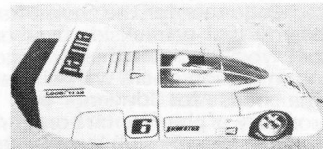

SCHKEE

1/8 SCALE CLEAR LEXAN BODIES

WINNER OF THE MONACO GRAND PRIX-MARCH F-1

Other new styles available — Ferrari 512M, Lotus, Ferrari and Surtees F.1. Coming 1/8 scale BMW 3201, New Monza, Mercedes 450

parma 13927 PROGRESS PARKWAY
NORTH ROYALTON, OHIO USA

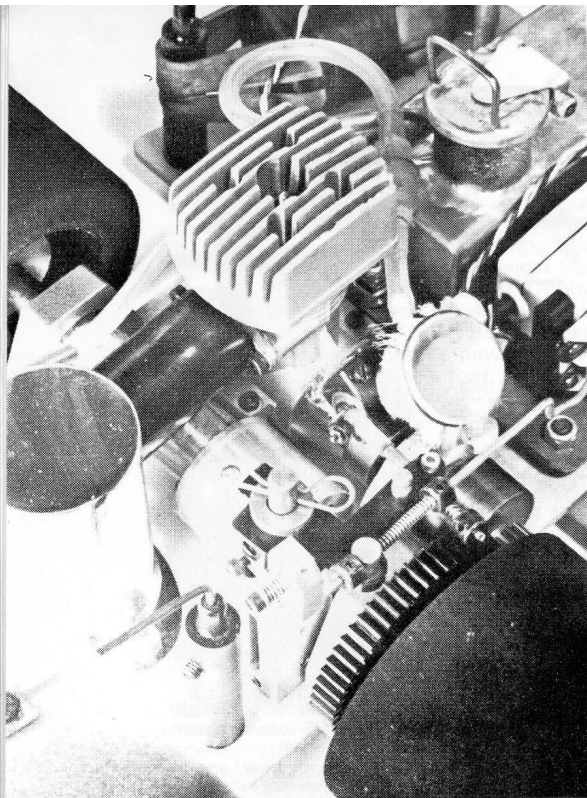

Note disc brake details, flip top to tank, SG silencer and of course the AMPS diff. Below: Note flat tank, roll bar and forward mounted Rx.

DD: In fact you leave the top bit as well as just using the lid?

Phil: Yes you cut the whole top off and then cut it in a circle round the solder joint and solder it on to the bottom of the tank.

DD: I note you have your tank on the side, whereas many people have it upright fashion.

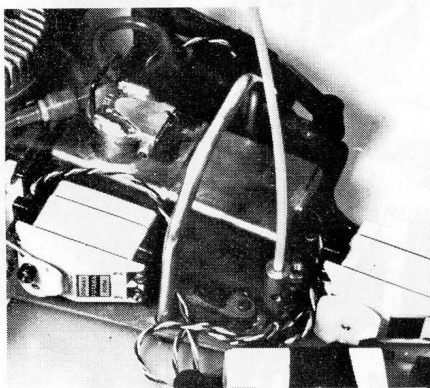

Phil: I don't think it is a good idea to have a vertical tank. The reason why we don't have a vertical tank is this. If the tank is only one inch in depth the fuel level can only alter by one inch, which is very important. If you've got a tank which is three inches in depth the fuel head can alter the three inches which makes a lot of difference between starting off rich and ending up lean. American tanks are mounted vertically which gives you a much greater fuel head difference throughout the tank range but they make their tanks chicken-hopper to compensate for this whereas our tanks are pure pressure. I have no trouble, I can run a tank dry every time. This is absolute reliability. We also have as you see a rollbar which serves also as a lifting handle. It really makes a difference, especially at Monaco, to the reliability, where we couldn't help flipping the car a few times as we were learning the circuit. I noticed the Americans knocking the tops of the tanks off and especially damaging their cylinder heads. Yes, together with an aluminium front body post, it pivots around and you protect the rest of the car and particularly the rear aerofoil — definitely a big improvement.

DD: Now tell me about the motor. . . OPS isn't it?

Phil: Yes, indeed, not exactly standard, in fact it has been worked over a lot. Only the con-rod and wristpin have been left alone. I never touch them. The Perry 61 pumper is fixed in with Devcon Sealite. . . but I can turn out an engine treated just like this for £65 including the Perry pumper though of course only a fairly limited number. . .

DD: What about that nice shiny silencer at the back?

Phil: That's an SG silencer. The reason why I like it is that it has two bolt fixing at the bottom. You get a shunt in a race and suddenly the silencer is noisy. The reason is this that someone hits you up the back and with a centre bolt fixing a la PB and the Serpent the silencer can rotate through 360deg; quite often it twists round and off pops your silicon tube which isn't strong enough to hold it. I've seen it happen more than once: it has certainly happened to me. It won't happen with the SG one. . . it adds to the reliability. I also think it adds quite a bit to the bottom end performance of the engine.

DD: The rear bumper is standard isn't it?

Phil: Yes that's right standard PB. The rear Plummer blocks are bearing blocks for the differential and are aluminium and not plastic, that's part of the AMPS package. I also have a ballraced conversion to the top of the disc brake a little block of aluminium

machined to take the race, in fact it is the same ballrace as is in the front wheels, in the front wheel journals, so that you reduce the amount of play you can get in the disc brake cam; and I use a Marker clutch, not a PB clutch, though there's nothing wrong with the PB clutch, it's that I just prefer a Marker clutch.

DD: What tyres did you actually use for the race?

Phil: The tyres I used at Monaco — on the front I had Associated 832 moulded rear I had Associated 2402. Hard moulds at the front and their 2402 racing rubber which suited the car admirably. And of course the Parma March Formula 1 body which is excellent.

DD: What about wheel hubs?

Phil: I had Thorp rears with adapters, or the PB can be used without of course.

DD: Two more little details? What air and fuel filters did you fit?

Phil: SG for air, and Delta for fuel.

DD: Generally you feel that this is going to be good investment in time and energy in making specials to order?

Phil: Well, I can only make so many, I can't mass produce them. . . but I do think there is a market for someone who does want a car. . . each car is hand finished. . . as you know even the best of kits you have to assemble some items don't fit properly. These cars are all handbuilt, everything is matched and absolutely perfect, with a backup guarantee from me that anything goes wrong I put it right. So I can promise

you one of the best driving cars you could possibly have.

DD: Now if a chap was not very well off and couldn't afford to have you set it up for him what things do you think most important that he should buy first as money allows?

Phil: First of all, definitely, the differential. . . that irons a lot of problems out, makes the car much easier to drive; on certain circuits it makes the car a lot faster. . . not on every circuit but it certainly makes the car a lot easier to drive and more consistent. Secondly I think our GRP chassis is a good thing. Everyone who has had one so far has been delighted with them. They are much stronger than the metal sheet. I don't think anyone has broken one yet and it won't tweak at all, it won't take a bend. It will break completely — no one has done one yet — but it won't bend, so that if you are in a final and you have a shunt you definitely know there is no possibility of the chassis being twisted and you having a very bad handling car. Also it definitely aids the roadholding, with the shape we've got at the moment the car handles incredibly well, so we're very pleased with that.

DD: Virtually all these bits and bobs you can buy individually in the shop?

Phil: You can buy everything separately and add to your existing PB if you wish.

A better view of tank and roll bar. Also fuel lines and Delta filter and lead back to silencer box.

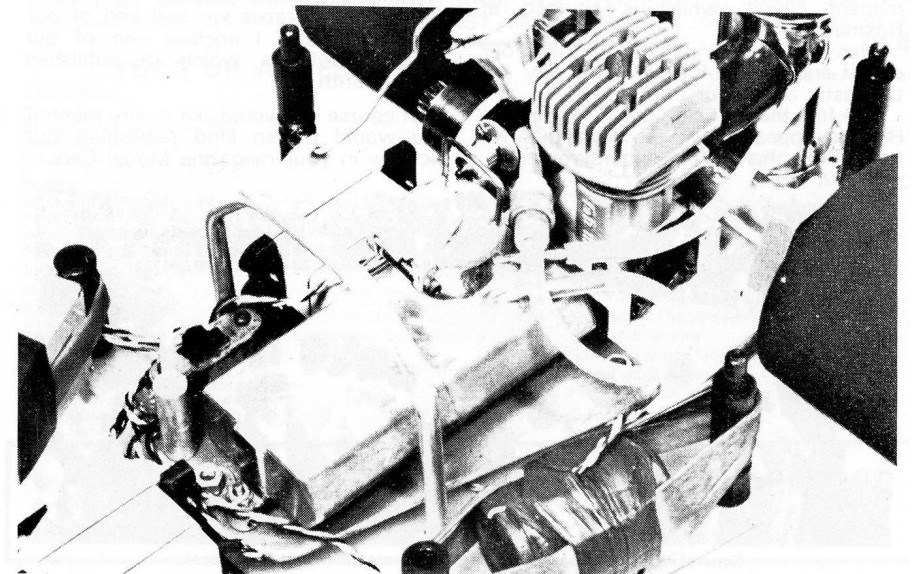



The 60 competitors with their cars at the last meeting at our track Rosmalen.

STOCK CAR RACING HOLLAND

BY JOHN WILSCHUT

AFTER reading your article, "Dutch Treat" in your magazine Model Cars, which we enjoyed very much, we hereby send you some more information of our club Stockcar Racing Holland.

Our club was founded in 1974 and that year already the first Dutch championships were being held. We are the only Dutch club specialized in racing with radio controlled stockcars on our own permanent circuit, which is situated at Rosmalen.

Many English drivers already visited our circuit and most of them were very enthusiastic about our track.

The fact that our club is very popular in Holland appears from the fact, that we have more than 300 members yet.

There are 10 club races per season and I think you probably know that our rules are nearly the same as the R.S.C.A.

In cooperation with E.S.A. we are very busy now producing collective rules. Every race there are about 500 spectators, the number of competitors each time is about 55, so racing is going on from 11 a.m. till 6 p.m.

I enclosed some pictures from some demonstration races we had and of our own track, also I enclose one of our Stockcar Bulletins, which are published every month.

Of course we would like it very much if you would be so kind publishing our pictures in your magazine Model Cars.

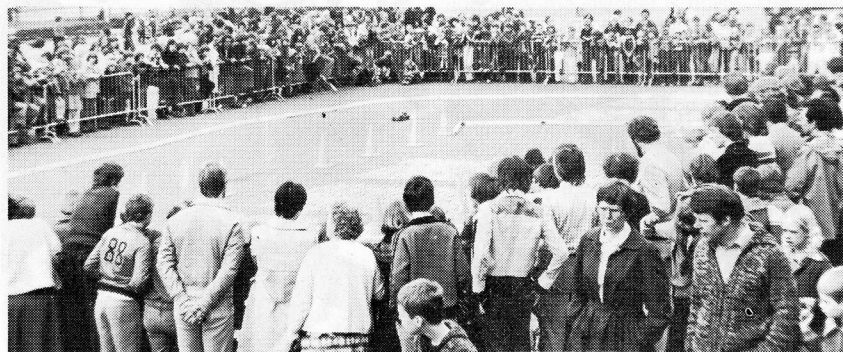

General view of one of our demonstration races in Mai at Oosterbeek.

9 Village Way East, Rayners Lane, Harrow, Middx. Tel. 01-8667770

R.C. CARS	£ p
P.B. International	75.00
P.B. Expert Comp	61.38
P.B. Expert STD	45.04
P.B. Dual	29.18
S.G. Comp.	66.72
Futura 3	72.00
Associated RC200	105.00
Associated RC1	59.90
Latest Delta 780 Super J	105.00
Mardave Formula	23.75
Mardave Saloon	23.75
Mardave Stock car	23.75
Ke'jon Stock car	29.50

PLUS A large stock of R.C. car spares always in stock including P.B. Associated, S.G., etc.

All prices correct at time of going to press but subject to alteration.

R.C. ENGINES

Just arrived:

Super Tigre X21 ABC car	44.57
Veco 19	25.95
HB 20 inc sil	25.95
OPS 21 ABC Car	42.95
K & B 21	47.50
OS 20 inc sil	25.97
ALSO Veco/McCoy conversion parts, including chrome piston/liner assembly, stoker crank-shafts, and High comp heads, etc. Send S.A.E. for price list.	

TUNE UP ACCESSORIES

SILENCERS	£ p
Semco Car	6.95
Semco Car (adapter Veco 19)	1.95
Preston Car Sil	7.95
S.G. Car Sil	7.50
TANKS	
PB Quick Fill (4 oz.)	2.56
Assoc. Metal Tank Kit	1.95
Assoc. Chicken Hopper Comp.	14.50
New GP Racing Tank (Sumped) with flip top	12.95
PB RACING HEADS	
Veco/McCoy	8.64
K & B 21	8.64
ST 21	8.64
PB Piston Slide Carb 3/8th in. or 7/16th in. Spigot	15.34
Perry 40 Carb.	6.95
Perry 61 Carb.	6.95
HB 20/Veco 19 Heat Sink Head	4.50
PB Heat Sink only	2.56
Perry 61 Pumper Carb	7.95



ACCESS! BARCLAYCARD! HOBBYCARD! H.P. TERMS PLUS FAST MAIL ORDER.

MONACO WORLD CUP

This is the Cup! All the items in the winning car can be obtained in the shop.

Appreciative thanks to Pitmen Martin Samuel and Ian Agnew

RADIO

Futaba medallion 2FD 22m servos	72.50
Futaba medallion 2 'brick'	66.75
Futaba twinstick 2 FD 17m servos (dry)	102.50
Futaba steerwheel '2' FD 17m servos (dry)	102.50
Sanwa mini 2 drycell	64.95
Sanwa standard 2 drycell	79.95
MacGregor 2 drycell	61.00
Futaba FD 17m servo (water-proof)	24.50
Nicad conversion for above always in stock.	

PLUS Full range of Futaba, MacGregor, Sanwa and Skyleader Radio.

Just Arrived! New!!!

AMPS Differential unit complete with rear mounting blocks and bearings, disc. Ready to fit to PB International

£49.95

NEW! M.R.P. Jerabee r/c electric, £59.95.

Lectricar with prop. speed control £44.87
Also large stock of BO-LINK, JOMAC, JEROBEE, ELECTRO CRAFT 1/12th ELECTRIC CAR KITS AND ACCESSORIES.

SPECIAL ITEMS

P.B. Air filter	£1.50
S.G. racing tank with sump and flip top	8.45
S.G. servo saver	£2.95
S.G. X.21/racing sil. -80db	£7.50
S.G. Futaba 17m side servo mount	90p
S.G. Alum. air filter	£1.95
Sullivan crap trap fuel filter	85p
Robert super pumper	£11.95
Perry 61 pumper carb	£7.95
O.P. S.21 car engine	42.95

specialists in **SKYLEADER FUTABA SANWA MacGREGOR**

Opening hours: Mon., Tues., Thurs. 9.30-6.00 Fri., Sat. 9-7.00. Closed all day Wed.



24-HOUR WORLD RECORD

WORLD RECORD ENDURANCE RUNS WITH DIARY BY NIGEL HEIGHTON

DATA: 24 HOUR RECORD

Start: 10.30 am Saturday 15th July 1978
Finish: 10.30 am Sunday 16th July 1978
 500 miles completed 11.23 am
Venue: Wombwell Sports Association Track
 Asphalt surface Length Inside 787.195 ft
 Outside 895.30 ft
 C.L. 841.2475 ft

Weather: Warm and dry during day
 Cool over night and cold wind at times
Drivers: Paul Padgin and Steve White
Car: PB International
 Amps Differential
 Tyres Front PB371
 Rear K & B 21 with Ted Booker pistons and
 PB slide carb
 Plugs Taylor 2v Longreach with bar
 Radio Macgregor
 Bodyshell SG Lexan Porsche 917
 Fuel G Max 10% Nitro

Achievements: 12 hours 245.68238 miles on full
 laps
 24 hours 482.08403 ditto
 Average Speed 20.086874 overall 22.727 on track
 Pit Stops 185 Time lost 2 hr 47 min 17 secs
 Shortest Pit Stop 3 seconds for fuel
 Longest Pit Stop 14 min 43 secs changing engine
 after trouble with setting carb
 Fastest Lap 23 secs (24.938 mph)
 3025 full laps completed
 Fuel consumption 4 1/2 gals
 Tyres 5 sets of rear 4 sets of front
 500 miles in 24 hrs 53 min 32 secs. 205 pit stops
 2 hr 51 min 54 secs lost

Ever since I first met Paul Padgin and talked "model cars" he kept saying "have you heard about those chaps in Hawaii who drove 465.82295 miles in 24 hours." He would then go on and on about how much he would like to make an attempt to break this record. In November 1977 we decided that, if we could, we would make an attempt in June or July 1978 on the track which was under construction at that time at Wombwell, Yorkshire.

After months of planning and preparation, the allotted day arrived — 16th June 1978. The car was a PB International fitted with AMPS differential, powered by a K & B21 engine, Ted Booker pistons, G Max fuel and controlled by the new MacGregor radio equipment. During testing we had used a power max rev counter. The floodlights were loaned by Search Plant Hire and additional assistance had been given by Perfecta Bedding.

It had been decided to start at about 8.30 pm. At 8.15 it was obvious that the start would be delayed as the second lap timekeepers had not arrived, and the tent pitched on the drivers' rostrum to keep the wind off the drivers was having to be refixed as it had blown down.

Paul Padgin and Steve White wearing their well-earned laurels and clutching the mandatory bottle of champers.

By 9.30 pm we were just about ready, the weather report was that it should be fine, but the track was still very damp from a torrential rainstorm some 4 hours previous. We had estimated that the car would be off the track for 2 hours in the 24, which would mean lap times of 26/27 seconds for the rest of the time we were running. From the warm up sessions the lap times were 30/31 seconds, but we hoped the track would dry up in about 2-3 hours. We also knew that, under racing conditions, a 24 sec lap was possible for our drivers Paul Padgin and Steve White of Team Hobbycard, but what times could we expect after 18 hours of driving? The task was indeed going to be long and hard.

The format was to be driving spells of one hour each starting with Steve, the transmitters to change with the driver; the receiver DEAC to be changed every two hours; and the pit crews after the first 1 1/2 hrs and subsequently every two hours. Thus at no time would there be an "all change" situation. The floodlights were to be checked for fuel every half hourly and the car every 7 1/2 minutes.

As the final minutes ticked by, the clocks were checked by Tom Martin the official observer, and I called the car to the line. The car was fuelled up and held till 5 seconds to 9.46 pm. I counted down the last five seconds and at long last waved the car off. 9.52 Pit Stop 1 for fuel only and the car was averaging 29.5 sec/lap 10.07 Pit Stop 3 — engine cuts for the first time, after refuel and restart it cut again after only a few yards. 11.18 Pit Stop 21 First wheel change. Apparent from two delays for the front tyres catching on the front mudguards. The main problem is the engine cuts. 00.47 50 miles in 2 hours 56 min. The track is still as damp as ever and the engine cuts excessive. If only we could get the lap times down, but 29/30 secs is still all we can record.

1.44. As the car comes in for the driver change, (4 hour) we feel the first drops of rain, but it only lasts for a couple of minutes. 2.51. The rain starts steadily now and within five minutes the rain is heavy. The lap times slip to 36/37 secs. 3.05. Pit Stop 62. The carburettor has jammed due to the rubbish the tyres are lifting in the rain. Over seven minutes are lost attempting to fix it, but still it keeps jamming so an engine change is made. A total of 19 min lost in this one pit stop. 03.27 Pit Stop 63. How it must have rained whilst the car was in the pits, there are puddles and ponds everywhere. Cap tyres are fitted. Pit

Ready to go: Rather more leisurely than later. Observer timing tent in background.

THE HAWAIIAN RECORD

The Hawaiian Record of 465.82295 miles in 24 hours was established on the Community College Parking Lot, Pearl City Hawaii on Saturday/Sunday August 30th 1975 by drivers Dionico Pascual Jnr and Carl Mizusawa under the American ROAR Rules. These rules have been scrupulously followed in the Wombwell Record. Some of these are given below:

6. Must finish with same chassis (no parts replaced must be repaired)
7. Must finish with the same bodyshell
8. Tyre changes permitted
9. Engine/clutch changes permitted
10. Radio components can be replaced if required
11. Distances shall be recorded for 3, 6, 12 hours
12. Various statistics shall be kept . . . pit stops, etc

Circuit: Road race course, minimum seven turns, minimum lap length 625 ft

Other rules dealt with observers, timing details, etc. The Hawaiian Car was a stock — out of the box — Delta 750SS. Tyres front Deltafoams on Delta white nylon wheels. Rear ditto. Differing only in width.

Engine: Mick McCoy's Veco-McCoy .19 production engine (the only engine used)

Carb: Delta slide valve Glowplug Fox standard r/c long reach

Radio: MRC F-713 three channel Servos Delta Systems Phase III Bodyshell: Associated Porsche 917-30KL Can Am

Fuel: Sig Champion (15% nitro)

Stop 64. The caps won't cope either, so it's back to normal tyres. Lap times of 46 secs. are recorded on a good lap as threequarters of an inch of water is swept off a lot of the track. 4.17. 100 miles completed in 6 1/2 hours. How can we ever make up the lost time to get back on target when the lap times are still only 33 secs, way off the 27 sec target? 4.55 Pit Stop 75. Paul goes up in the knowledge that we have decided to stop at 8 hours. We don't stand a chance of beating the record in



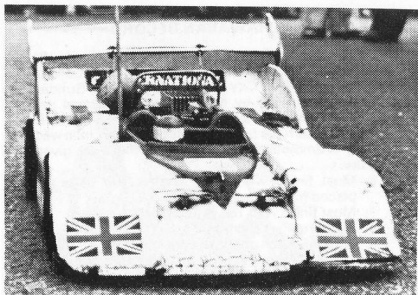

Rather battered car after the record. You can hardly read the Hobbycard on aerofoil.

these atrocious conditions — what a disappointment, but we feel that we would be better having a repeat attempt rather than go on wearing the equipment out. 5.46 — The 8 hours are up. We do one more lap as a final out of defiance as it means we have 120 miles under our belts.

The car body is taken off, the dirt is oh so thick and the car feels about 10 lbs. The radio equipment has stood up to 8 hours of wet and damp conditions and never missed a beat. The engine cuts remained a mystery but we suspected that there was some scaling of the alloy fuel tank. We all depart home and disappointment increases when within 24 hours there are ideal weather conditions! The "if only" "perhaps we could have" are even more profound.

Two days later, Paul contacts me to nominate a repeat attempt date of 15/16 July.

ATTEMPT NO. 2

Friday evening 14th July and personnel are again starting to arrive at the track side. By 9.15 Paul, Steve and myself have our caravans in position. The Perfecta Bedding Dormitory was opened up and the lap counting tent erected. As darkness descends the Search floodlights are cranked into position, and their engines started so as to check the lights. We think we can improve the illumination of the track if the lights are adjusted for throw — an easy task, but we did have to lower the tower first. This kept everyone warm winding the various handles involved. At mid-night the last caravan arrived — pitman John Russell hotfoot from a 1/12th scale electric car meeting. We at last depart to our beds.

Saturday 15th 8.15 am. Activity at the track side as the teams of helpers begin to cut the grass around the track and erect the main Timekeepers/co-ordination office tent. At 9 o'clock all officials are on site. 9.45 the grass is all cut and the track swept. The drivers can now have some practice and decide which tyres to use. At 10.15 am the pre-event meeting holds to

the format and change over periods as in the previous attempt and the start is confirmed for 10.30 am. The marshals, time keepers, lap counters and official observers take their places. At thirty secs to the off car is called to the line, filled with fuel and, at five seconds held on the brake for the countdown, 5,4,3,2,1, — off. We all watch and time the first few laps anxiously. The weather is fine but cloudy and the track is dry. At ten laps the average is 24.8 secs — we all breathe a sigh of relief — at least we are in with a chance, from the onset this time.

11.01. Pit Stop 4. Disaster strikes after 31 minutes! Steve has wandered off the edge of the straight and hit a tent peg holding up the back of the counters tent. The steering servo output arm smashed. The servo is changed as a precaution as the car must have been flat out when it happened. 4½ min. lost.

11.32 One hour and 20.3 miles completed. We are jubilant.

11.53 Pit Stop 9 First engine cut. Paul has been driving for 27 minutes. Not quite as fast as Steve, but still very fast nevertheless.

12.02 Pit Stop 10 Poor left lock is the cry, perhaps the DEAC has only lasted 1½ hrs — so a fresh one is installed.

12.14. Pit Stop 12 Still poor left lock this time the servo is changed.

1.25 Pit Stop 19. Nearly 3 hours. The steering servo wires have been chafing against the chassis and snapped. The servo is changed and this time more attention is paid to keeping the wires clear of obstructions. As the car leaves the pits we have 60 miles in 3 hrs. dead.

1.47. The log records "sun is now shining, and the pit crews are having fish and chips followed by ice cream."

2.00. Pit Stop 22 Paul is again claiming poor left lock. The Rx, deac and and steering servo is again changed. Still the lock is poor. At last we suspect the Transmitter steering pot. The other Tx is passed up and at last the fault has gone. Immediately Paul's lap times improve — so simple a fault yet we had been looking in the wrong place and losing time.

2.22 Pit Stop 25. Nearly 4 hours gone and the clutch is giving trouble. A snapped O ring is suspected, but subsequent inspection revealed seized clutch bearings. Engine 2 is fitted. Paul complains of the cold wind hitting his back. On looking round we find an old wooden hut (used for a toilet in the past) and this is carried up on to the rostrum and the driver can sit inside — the comments that followed will not be

308 PIT STOP



MARDAVE kits: 1/4th Scale McLaren M23; Lola T294; Capri RS Saloon; Firenza sal; Stock car all complete with clutch **£23.75**. New from Mardave — Electric Car, complete **£38.95**, MRP from **£55.95**
P.B. PRODUCTS: Expert Junior **£35.67**; Expert standard **£45.05**; Expert Int'l **£75.00**. Expert Competition **£55.21**. Racing dble **£29.30**.
Kejon Stock Car **£28.50**. Lectricar kits **£44.95**.
SG Electric Car **£23.50** (less motor)
IRVINE 20RC £35.95
ENGINES: ST X21 with ht. sink hd. **£44.12**. OPS 3.5ccs **£39.95**. K & B 3.5ccs car spec'l **£47.50**. Veco 19 car spec'l **£25.95**

EXTRA LARGE STOCK OF SPARES FOR PB INTERNATIONAL
ALL MAKES OF R/C EQUIPMENT STOCKED AND FULL RANGE OF SPARES
We accept ACCESS, AMERICAN EXPRESS, BARCLAYCARD, BANK AMERICARD,
HOBBYCARD, QUADBONDS

WORLD-WIDE MAIL ORDER

HENRY J. NICHOLLS & SON LTD.

The World's Greatest Model Shop for the Enthusiast!

308 HOLLOWAY ROAD, LONDON N7 6NP. Telephone: 01-607 4272.

(2 mins from Holloway Rd. Station on the Piccadilly line)

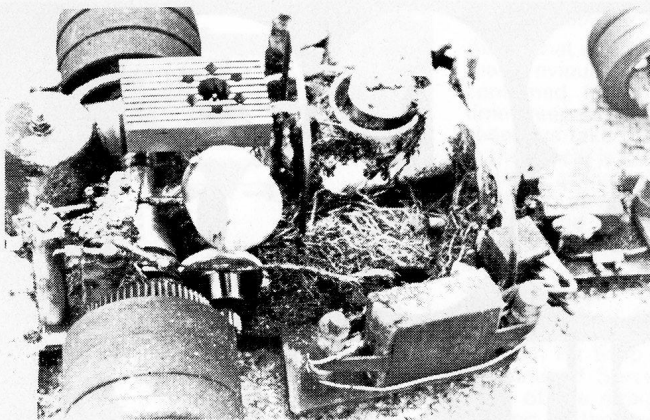

End of race debris collection — grass, twigs, dirt sucked in from everywhere but still the car went on.

Nigel Heighton poses with the car and the team of helpers who did all the unromantic things like marshalling, making cups of tea and lap recording.

recorded but can be well imagined — 3.34 100 miles in 5 hrs 4 min and we are ten minutes in hand on the record-breaking schedule.

3.50. Pit Stop 43 This second engine has not run so well as No. 1 and will only go five minutes on a tank of fuel as against nine with Engine No. 1 At last we think the problem has been located, the carburettor body was found to be broken. Engine No. 1 is refitted and we have lost 7½ minutes.

4.16. I ask the pit crews to check the drive gear clearance as the tyres have not been changed yet.

4.19 Pit Stop 48. Too late! The gear has been caught on the concrete edging and the teeth have stripped. New tyres are fitted whilst gear is being changed.

4.30. Pit Stop 49. Wire on the receiver chafed through this time the spare is fitted.

7.35. Pit Stop 73 Just over 9 hrs. gone and the first real problem for three hours — the front axle beam has come loose.

8.22. 200 miles in 9 hrs. 52 min. — we have about 50 laps in hand on the record.

8.28. Pit Stop 81. The 2nd set of rear tyres are fitted. The last eight pit stops caused by engine cuts. When the car is sent out the cuts have vanished — perhaps the engine was over hot and it cooled during this stop.

9.40. The car passes the USA 12 hour mileage in 11 hrs. 10 mins but then they did more miles in their second 12 hours.

9.52. Half way to the record mileage and we have thirty-eight minutes in hand. The floodlights have just been put on.

10.30. 12 hours gone and we have 1542 laps recorded. New World Record for 12 hours is 245.68238 miles and we were only yards from adding another full lap. The car body has really taken a pounding over the last 45 minutes as dusk fell and it is

decided to have a major repair at the next pit stop.

10.36. Pit Stop 96. Whilst the body is being repaired by wiring the loose bits together, the car is cleaned, the differential is topped up with oil, new front tyres are fitted and the Rx DEAC is changed. All in 8 min 19 secs. We find that to date we have lost 83½ minutes which means that our estimate of 120 in 24 hours is way off. Each hour lost means 1 second a lap faster overall is needed to break the record from our estimated lap times. As the car goes back on the track the steering is not working properly but this was only the new front tyres catching the damaged body.

10.51. Pit Stop 100. Fourth pit stop in six laps — the engine will not run. Fuel filter changed.

1.08 am Pit Stop 115 One lap off 300 miles and more re-wiring of the bodysell is required.

1.10. 300 miles in under 14.41 — we're healthily on the correct side of the record.

2.04. Pit Stop 122. 320 miles and the second rear gear has just stripped.

2.20. It's unbelievable — Paul is having his usual bad luck with six pit stops losing 17 minutes in the process PS121 Lap 2008 fuel only PS 122 LAP 2009 gear changed PS 123 LAP 2010 Steering lock checked. PS124 LAP 2011 engine cut. PS125 Change front bumper and Rx DEAC. PS126 Car all over the place, a delay occurs whilst Steve's Tx is taken off charge and passed up and everything is OK. The steering pot is still giving the trouble. If only we could have got the spare part when we first hit the trouble — still we were running again.

3.23 Pit Stop 133. Steve's Transmitter has now gone flat due to its reduced charge period when Paul had claimed it. Jeff

Lindstrom still has the other Tx in bits trying to fix the pot. In desperation the good Tx DEAC is given a 6 min. high power charge and the pit crew do some maintenance and clean some of the dirt off the car.

3.45. Pit Stop 137 A dry cell Tx has been located and passed into service after a slight delay to reverse the channel plugs on the Rx. We are lucky as the mode is now compatible.

4.32 Pit Stop 143. 18 hours gone 365 miles. The fuel tank has broken so whilst it is being changed the body is again wired together. The carburettor is tightened and we have another 6½ minutes.

5.31 Pit Stop 149. More rear tyres required. Steve looks very tired having just completed his 10th hour of driving.

6.02 Pit Stop 153 Engine has no power — stalled.

6.04 Pit Stop 154. 19½ hours. Car not got any power after repeated attempts to adjust the mixture. The engine seems tight and suspect a partial seizure, after all it has been running 14 hours. Engine 2 re-fitted and the car is returned to the track — 15 minutes lost. The progress graph dips drastically. Engine No. 1 is opened up but it is all right, it is not seized, it's just its amazing compression. Further checks show that the mixture needle has a stripped thread. Paul's special Jinx has struck again.

6.33 Just 4 hours left to go and we have 400 miles to our credit, let's hope we keep clear of any more trouble.

6.31 Pit Stop 175 22 hours gone and 24 miles to go to the record. The No. 2 engine has started cutting with regularity as the clutch is faulty. Engine 3 is prepared for fitting. Paul comes down from the

rostrum. Steve is still in a chair at the side of the track saying he doesn't want to drive, however, he is in position by the time the car is ready to go out — 8 minutes lost again.

9.31. Paul starts his 12th session. We have 59 minutes left and 25 laps to go to break the record.

9.38. Pit Stop 187 Fuel stop — time to change the DEAC. Panic in the pits as the car won't start but it is only the plug blown.

9.44. After 23 hrs 13 min 20 secs we pass the record mark. A cheer goes up around the track. At subsequent pit stops the engine is cutting but we decide to press on and not change the engine again — could be the clutch again.

10.30 We count down the last five seconds and mark the spot the car has reached. 482.08403 miles. We are going for 500 miles now as it should come up in under an hour.

10.49. Pit Stop 199 Mike Newman invents a catching hook to lift the car off the track as it comes in a fuel fill — it saves stalling the engine.

11.24 — we have 500 miles in 24 hrs 53 min 32 secs. Well, that's the way it was and a very tired jubilant party celebrated the victory for the World Records for 12 and 24 hours and 500 miles. All that it remains to do is thank everyone for their help, and especially those friends from the Bradford and Wombwell clubs, because without them we could not have managed to take the record. Also to the manufacturers for their assistance and to Wombwell Sports Association for building the track which made it possible, Search Flood Lights and Perfecta Bedding.



CATFOSS CLASSIC

BY DICK WINDER

The morning dawned for yet another Catfoss Classic. The skies had a sinister, menacing look about them, but several campers had braved the conditions and were up bright and early in the morning. Racing was underway at 9.30 and the three sessions of ten lap heats for the F1 qualifying times were completed very quickly, and without a hitch. As expected Preston, Booth, and Martin were three of the qualifiers straight through to the final along with Steve White, whose liking for the Catfoss track seems to have been reaffirmed. Dave Martin however was not as fast as one has come to expect and seemed a little troubled.

Ken Wright, Bob Errington, Paul Padgin made a fast start going the way he obviously intended to carry on. Very quickly he was two laps up. The rain became more than a threat in this race, starting off as a drizzle and falling heavily towards the end. It did not put Paul Padgin off though and he stayed clear out in front till the end. The rain was causing the others more trouble and after many off track excursions and a rather confusing race it was Bob Errington who managed to come through the field after a poor start and clinch the remaining place in the final.

The F1 Handicap Final was also rather wet. Nigel Heighton showed at first but had trouble early on and it was Bailey and Elliot who took command of the race, Bailey turning out the winner. The rain eased slightly for the F1 Final but the track was still very wet. This did not however spoil a classic race. Dave Martin and Steve White took the lead from the start. The trio of Preston, Padgin and Booth made a slow start. White then took the lead from an unhappy looking Martin and Preston, Padgin and Booth started closing up. Just as Preston closed on the leading pair, White retired, and suddenly Preston found himself in the lead as Dave Martin's car started to slow, Padgin was also having trouble by this stage and it was Errington and Booth who slipped by Martin next. About half distance Booth slipped by Errington and set about whittling down Preston's small lead. These two really

F1 FINAL

	Car	Motor	Carb	Front Pod	Diff	Front Tyres	Rear Tyres
1st D. Preston	PB/Spec	OPS	Own Slide	Fibreglass	Thorp	371	UFRA Slick
2nd P. Booth	PB/Spec	OPS	New PB Slide	Fibreglass	Thorp	371	PB 374
3rd B. Errington	PB int	OPS	New PB Slide	NO	PB	371	Ass 2402
4th D. Martin	PB/int	K & B	Peri Pump	PB	NO	371	Ass Slick?
5th P. Padgin	PB Int	OPS	PB Slide	PB Narrow	NO	371	PB 374
6th S. White	PB Int	K & B		PB Narrow	NO	371	Moulded MedHard

mastered the conditions but Preston held off the very strong challenge of Booths to the end, and Errington came in third a little way down. Dave Martin was fourth having retired near the end, and Paul Padgin fifth by merit of having kept going longer than Steve White.

It was onto the GT heats before lunch, and with only a small break in between the heats for lunch, the meeting was running right on schedule. Ken Wright, John Darrington, Chris White, Ken Payne, Bob Errington and Mick Newman made the semi final whilst Dave Preston, Paul Padgin and Phil Booth, along with a surprised but delighted Woodford, were straight through into the final.

Things were getting very wet by now as the rain was coming down relentlessly and wouldn't clear up. It was at this stage that the racing became difficult to follow with so many cars stopping, starting, flying off the track and even going the wrong way round! So suffice it to say, Ken Wright and Bob Errington qualified through for the final. Also in the GT Handicap final McFadyean was first, John Darrington second, now figuring much more often in the results, and third was Elliot.

The GT Final was another entertaining race with plenty of incident to keep the spectators on their toes. Ken Wright took the lead for two laps but ran into body fixing problems and was sidelined, leaving Phil Booth, and Paul Padgin being trailed by Errington and Preston. The race looked as if it were shaping up for another duel between Preston and Booth when Padgin had trouble, but suddenly Preston had trouble and was out. This left Booth out in front but then suddenly Booth's motor cut and he was in the pits. Padgin was past and Booth back on only to have his motor cut again. It looked like a victory for Paul Padgin but somehow Ken Wright who had been circulating very consistently after his earlier troubles crept into the winning position almost unnoticed leaving Padgin in second place close behind. Phil Booth managed to struggle into third with a sick engine, Bob Errington fourth after a few pitstops, Dave Preston fifth and Woodford sixth after a disappointing final for him.

GT FINAL

1st K. Wright
2nd P. Padgin
3rd P. Booth
4th B. Errington
5th D. Preston
6th Woodford

GT Handicap

1st: McFadyen
2nd: J. Darrington
3rd: J. Elliot

F1 Handicap

1st: Bailey
2nd: J. Elliot
3rd: N. Heighton



MODEL CRAFT
5 CROSS ST. BLABY
LEICS. ENGLAND
TEL. 0533 771397

SHOP OPEN 9-6 p.m. Mon to Sat.
Closed all day Wednesday.
RING IN YOUR BARCLAYCARD OR ACCESS

POSTAGE: Parts 50p; Decals 10p, Kits FREE



1/12 driver figures solid cast, very detailed 49p each

1.2 A.H. Nicads, vented fast charge type £1.65 each

Alloy front wheels for Mardave £3.60 Matching rear Trims £3.60

MARDAVE 1/12 Scale car kit complete with Nicads, motor, body etc. value at £37.50.

6 WHEEL TYRELL

ABS bodyshell plus instructions on how to adapt to the standard MARDAVE electric car chassis Price £3.95 P & P 35p.

1/12 scale bodies ABS

F1 BRM	£1.45
F1 Ligiers	£1.45
Porsche Saloon	£1.95
BMW Saloon	£1.95
Shadow G.T.	£1.95
VW Beetle	£2.50

MARDAVE SPARES 1/4 SCALE

Rear axle bracket	70p
Brake unit	33p

SERVO SAVER

Steering bellcrank complete	66p
-----------------------------	-----

FRONT SUSPENSION

Complete	£2.90
King Pins	10p ea.
Coil springs	10p ea.
Axle, with nylon block	20p ea.
Steering arms, LH or RH	20p ea.

FLYWHEEL/CLUTCH UNIT

Complete	£3.75
Clutch shoe	25p ea.
Tubular pins	3p ea.
13t hardened steel gear	70p ea.
Bush for gear	25p ea.
Cork lining	6p ea.
Clutch drum complete with gear and cork lining	£1.60
Clutch springs	8p ea.
REAR AXLE	55p ea.
Bearing	20p ea.
Bearing lock nut	9p ea.
1/4" Nyloc nut	6p ea.

WHEELS

Front	35p ea.
Rear (with integral drive gear)	70p ea.

MARDAVE 1/12 ELECTRIC CAR KIT SPARES

Chassis plate, drilled	95p ea.
Front axle beam moulding with steering arms	70p ea.
King pin	6p ea.
Bellcrank	20p ea.
Bellcrank attachment nut	6p ea.
Front stub axle with nut	12p ea.
Track rod, complete with over-ride stud, springs and collars	70p ea.
Rear axle bearing blocks (Pack of 2 with 4 screws)	70p ea.
Side trays (Pack of 2)	70p ea.
Front wheel	25p ea.
Rear wheel with 2 grub screws	55p ea.
Front tyre	35p ea.
Rear tyre	70p ea.
Rear axle	15p ea.
Drive gear (Hardened steel gear with 2 grub screws)	75p ea.
Speed controller (Complete with resistors, wiper arm, etc.)	£2.75 ea.
Speed controller printed circuit board only	90p ea.
Speed controller resistor only	30p ea.
Speed controller nylon wiper arm	20p ea.
Speed controller pivot stud, for wiper arm	8p ea.
Speed controller brass contact	8p ea.
Speed controller coil spring	8p ea.
Aerial/switch plate, black nylon	30p ea.
Throttle servo/speed controller mounting plate, black nylon	30p ea.
Front bumper plate	35p ea.
Charging leads	£2.95 ea.
Collars, for linkage wires, with grub screw	15p ea.
Screws, any size	3p ea.
Nuts any size, except nyloc	1p ea.

TYRES

Front, standard rubber	60p ea.
Front, hard rubber	70p ea.
Rear, standard rubber	£1.05 ea.

RADIO CRATE

Complete	£1.30 ea.
Driver figure	26p ea.

ACCESSORIES

Engine silencer	£2.35
Engine heat sink (for extra cooling)	£1.25
Transfers (Giant size sheet, 84 sponsors decals + 35 numbers)	£1.25
Starter sheet (4" dia. hard rubber, for electric starter)	£1.35
Air filter for Perry Carb	80p

STOCK CAR

Silencer	£2.35
FRONT SUSPENSION Complete	£2.50

REAR SUSPENSION

Radius arm	38p ea.
Radius arm spring	15p ea.
Radius arm attachment nut	12p ea.
Rear axle	40p ea.
40 Tooth drive pulley with tube pin	70p ea.
Drive belt	55p ea.
FLYWHEEL/CLUTCH UNIT Complete	£3.75
Clutch drum with 8t pulley, cork linking and retaining washer	80p

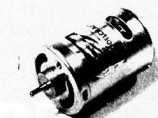

'Cyclone' type motors Mabuchi Re. 54. Only £2.99 each

Hollow 'Boots' for outdoor running. Fit over standard tyres either treated or slicks 91p per pair front or rear

Irvine 20 car now in stock Schneurle ported, dyke ring, metal carb, very potent at £35.94 all spares available

Alloy front axle beam to fit standard Mardave parts. 8 deg. camber incorporated transforms the handling



BRITISH NATIONAL 1/12 ELECTRIC R/C CAR CHAMPIONSHIP PONTINS HOLIDAY CENTRE : BREAN SANDS : SUNDAY, OCTOBER 8

Rules and entry forms available from

MR. T. DAVENPORT. 200 WINDMILL ROAD, COVENTRY CV6 7BE.
TEAM ENTRIES : INDIVIDUAL ENTRIES : CONCOURS D'ELEGANCE.

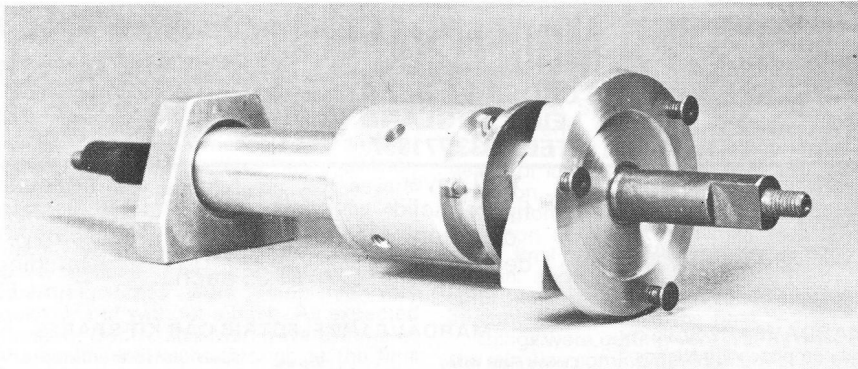

SOMETHING DIFFERENTIAL PT2

BACKGROUND TO THE DEVELOPMENT OF MODEL DIFFS BY IAN ANGWEN

IT WAS a hot beautiful day. The pits at the Monaco Race Track were quiet as it was lunchtime. There was a tap on my shoulder "I've just been having words with your father! He says you would probably love to do an article for me on differentials?" It was our editor "Dickie" Laidlaw-Dickson. Now this request in any other circumstance would have sent me running, being one of those unique pupils at school who didn't quite achieve the literacy of that fellow William Shakespeare. But, I was feeling rather pleased, as both the AMPS differentials running in the World Cup had just qualified for the Final, setting the two fastest times, so I agreed.

Now, 900 miles away back in rainy old England the awesome truth of what I had agreed to was beginning to dawn on me. The subject "differentials" was a very vague parameter within which to work, especially as the basics had already been covered in a previous article. After a couple of calls from Dickie reminding me that I had an article to write, I decided to re-examine full-size practice and see what information could be gathered to assist me. So with a few more phone calls an appointment was made to see Jack Knight of Jack Knight Developments Limited. After all, who better to go and see than the company who produce the differentials used by 95 per cent of the current Formula One teams.

Jack Knight Developments have been in existence for over 18 years. In the early days the company was heavily involved with the "Cooper" Organisation making

gear-boxes and many other components for their Formula One and production racing cars, and during this time enjoyed a good deal of success. Unfortunately, when Coopers went bankrupt it left the company with very little outside work, and a decision to diversify was quickly made. Hewland Gear-boxes were well established amongst nearly all the other Formula teams, so another direction was needed to keep the company going and duly the heavy duty Imp and Mini gear-boxes were produced.

Despite this diversification Jack Knight still kept in with the Formula One scene and today there is hardly a team running that isn't using something made by Jack Knight Developments whether it's steering racks, suspension uprights or Limited Slip differentials (L.S.D. for short). The differential being particularly popular amongst Formula teams for its smooth and effective operation without the "snatching" that can be experienced with other types of L.S.D.

With David Knight, Jack Knight's son, I struck gold, as he has a few ideas for producing the perfect limited slip differential. A unit that gives a pure differential action but has no tendencies to spin should a wheel break contact with the road. Having whetted my interest, he would commit himself no further, but was very helpful regarding units that had been tried.

The most widely used type of L.S.D. in rallying and saloon car racing is the clutch type produced by ZF and Salisburys Transmissions. This uses the principle that a bevel gear when running, exerts a force along its shaft. This force is used to

Heading shows "our hero" the production version of the AMPS differential for PB International.

ACCESSORIES



DIFFERENTIALS

2 NEW WORLD RECORDS

We would like to congratulate Paul Padgin and Steve White for setting a

NEW WORLD DISTANCE RECORD of 482.084 miles in 24 hours

NEW WORLD ENDURANCE RECORD of 500 miles in 24.897 hours

Said Paul afterwards, "I don't think I could have done it without the AMPS differential."

Well done Paul!

1ST EUROPEAN CHAMPIONSHIPS

LILFORD PARK, AUG. 12th/13th 1978

G. Thirans, Brussels, BELGIUM

Five out of the Top Ten were running with differentials

The unit is at present only available for the P.B. International. Versions for the Associated RC200, the Serpent SG and the Challenger will be available shortly. They are already in use in Holland, Germany, France, Italy as well as Britain. See the **AMPS diff at your local Model Shop or contact:**

AMPS LTD. STATION HOUSE, HARTHAM LANE, HERTFORD. HERTS.

Telephone: Hertford 56597. Trade Enquiries welcome

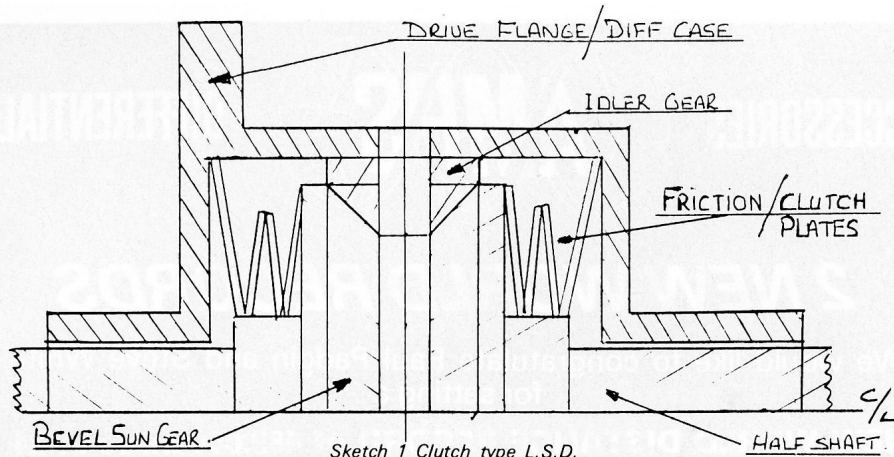

Sketch 1 Clutch type L.S.D.

engage clutches placed between the half shaft gear and the differential casing. (see sketch "A") When a wheel starts to spin the force created by the gear compresses the clutches in order to create a force equal to that of the wheel still on the ground, thus stopping the wheel from spinning and giving two wheel drive again. Although this unit is reasonably simple and in theory would be easy to miniaturise, I think its effectiveness would be lost due to the diameters of the clutch plates that would have to be used.

A second type that David Knight's knowledge has only been tried by the Tyrrell Formula One team is called "A Reverse Viscosity" LSD, and works along the lines of a fluid clutch. It consists of a differential gear train and four vanes, a pair attached to the diff. case one at each end, and one on each output shaft. As these took up a major part of the area in which the unit had to fit, the gear train had to be condensed into the remaining space. This was accomplished by using an epicyclic gear train with inner and outer ring gears and two idler gears.

EURO CHAMPS AT LILFORD PARK

Formula: 1 G. Thiran B 67 laps; 2 J. P. Ruchat CH 67laps; 3 F. Sabattini I 67 laps; 4 H. Olsson S 66 laps; 5 Collina I 56 laps; 6 R. Andexlinger A 55.
Sports/proto: 1 D. Martin GB 93 laps; 2 P. Bervoets NL 92 laps; 3 Debbie Preston GB 91 laps; 4 R. Ton NL 88 laps; 5 P. de Carro S 78 laps; 6 P. Greeno GB 54 laps.
 Full report in next issue.

In action it worked as follows:— when a wheel began to spin the vane on the output shaft rotated in relation to the diff. casing vane thus exerting a retarding action on the half shaft and giving the limiting effect they were seeking. The major problem with this action was that after a short period of time the reverse viscosity fluid used began to boil and no longer worked. This system lends itself very well to model application as it is now general knowledge that by playing with different viscosity oils it is possible to obtain different limiting effects and by adding vanes, it can only increase this. We are experimenting with this idea at present and will report our results at a later date.

The third type of diff. known as the "Cam and Pawl" LSD is the one produced by Jack Knight Developments, and is distinctly different from the others in that it uses no gears at all, but works on a roller clutch principle. The design of this is originally German and Jack Knight built his first unit from photos published after the Second World War. Maybe before I try and explain how the differential works I should explain how a roller clutch works.

In construction it is basically the same as a needle roller bearing but has an outer race with an incline on one side of the roller. When the outer race is rotated against this incline in relation to the shaft passing through the middle of the clutch or "the inner race", (see sketch "B") the roller becomes trapped between the incline and the inner race thus locking them together. The cam and pawl diff. works along the same lines, but is bi-directional as apposed to the roller clutch which is uni-directional. One half shaft forms the inner race with external peaks (inclines) and the other half shaft forming an outer

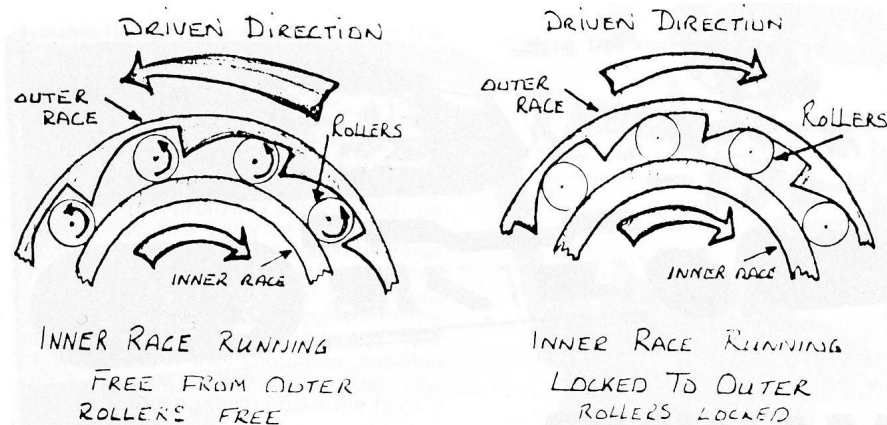

Sketch 2 Roller Clutch.

race with internal peaks. The pawl or roller is then placed between them and connected mechanically to the drive flange (see sketch "C"). Now providing there is a load on each half shaft i.e. both wheels are on the ground, the rollers will then lock between the peaks on the two half shaft ends and given an equal drive to both wheels. A different number of peaks to the number of rollers enables the unit to work effectively even when cornering.

The only drawback (and there is always something) is that if a wheel should lift clear off the ground it no longer exerts a load on the differential unit and therefore the rollers cannot lock, so losing drive. I don't think its application in models would be of any benefit unless the vehicle was fitted with suspension, enabling the rear wheels to remain in contact with the ground all the time, rather than lifting

wheels as the models do at present due to chassis flex. Having said that, I still feel it is worth a try on the standard set ups as any development that can be done now could be of benefit to us in the future and so I have one on the drawing board prior to construction and look forward to getting stuck into this project.

So there we have it. Three different systems used in full size all of which could be miniaturized, but as to their effectiveness we will have to wait and see. In this article allied with those that preceded it (Issue 5) we have now covered the basics of full size practice, from the pure and simple geared unit to the racing L.S.D. Next issue I hope to tell you about how I got involved in the first place and what problems we encountered in trying to get our diff. to the production line, as well as any other up to date information I have.

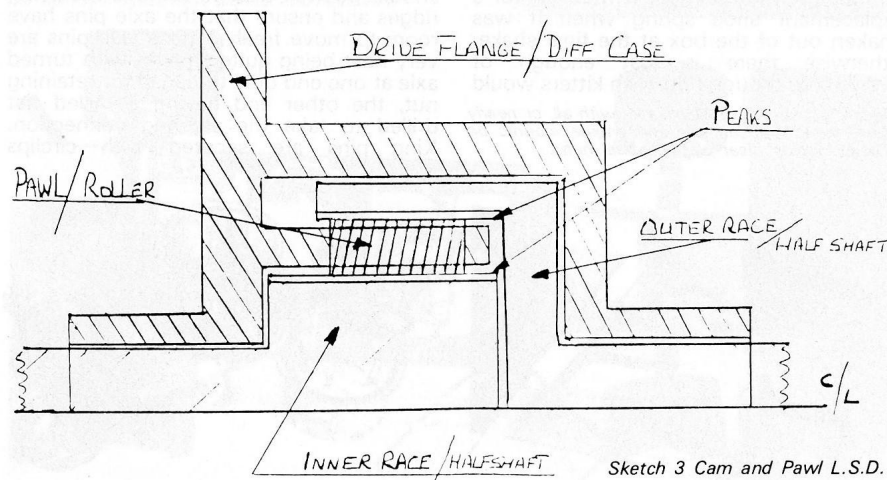

Sketch 3 Cam and Pawl L.S.D.



MAKING MANTUA

The Mantua kits were amongst my favourites at the German Toy Fair this year and I was delighted to learn that C.I. & R.A. Thompson were bringing them in as distributors. Two options are offered the Model 1000 (which is the one about to be built) selling at around the £50 mark and the rather more conventional Model 2000 at twice the price intended for the more ambitious driver. At first sight the kit is a model trader's delight being so elegantly packaged for display with all the parts in their purpose-made pockets under a protective clear sheeting. But watch out, Mr Model Trader, and ensure that your customers check that everything has been accounted for before throwing away the wrappings! I had almost written off for a replacement shoe spring when it was shaken out of the box at the final shake; otherwise there is just enough of everything, though I do wish kitters would

Elegant packaging of Mantua kit with all, or nearly all, to view. Moulded axle and engine mounts on chassis. Clever clear plastic wheel hubs.

slip in a couple of extra things like circlips to save that regular gravel for flipped out bits.

The one piece chassis made, so the instructions say, in nylon-fibreglass, is a sturdy 1/8th in. thick or more, with strengthening ribbing on the underside for threequarters of the length leaving the front with some flexibility. Radio box and the lower parts of the rear axle plummer blocks as well as the lower part of the engine mounting blocks are moulded integrally with the chassis. Most of the assembly is with self-tapping screws through ready-drilled holes, some of which are not compatible with the more usual servos, and may even not be in the right place. To avoid scratches file down their protruding tips.

Front axle beam is of the same black nylon fibreglass and the king-pin bearers should be well filed to remove moulding ridges and ensure that the axle pins have room to move freely. These axle pins are very neat being quite straight with turned axle at one end duly threaded for retaining nut, the other end having a milled flat drilled to take the steering connection. King pins are secured with circlips

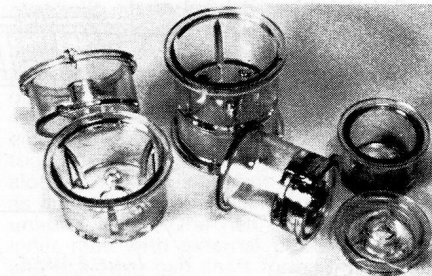
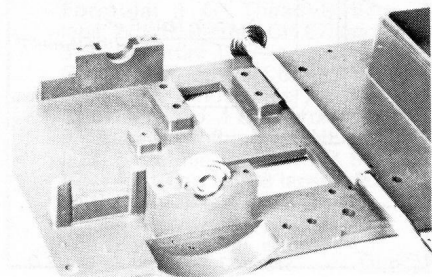

(horrible things!) The nuts holding on the wheels were not as described locknut type but plain nuts, so should be secured with Loctite.

Wheel-hubs introduced another novelty. They are clear Macralon and each is in two pieces to be screwed together with three selftapping screws. Front wheels contain bronze bearings which go between the two parts before screwing together; do not overlook tapered bearings to go on rear axle. Wheels have slight rims to retain the tyres. No mention of any need to glue the tyres in place appears in the instructions. The little rims will **not** hold the tyres on and they should be glued on with Evostik or similar in the usual way. Before assembling them I gave the hubs a quite spray of silver paint.

Rear axle is tapered at the ends and threaded for wheel retaining nuts. A brass tube spacer is provided. Double shielded ballbearings locate in the plummer blocks with retaining blocks to screw over them. Crown wheel is fixed to driving wheel with four selftapping screws separated from the Macralon hub by four distance pieces of brass. Engine for which the test chassis was intended is the OPS (perhaps a little ambitious for what is really a low priced **almost** beginners' kit) so that motors such as the ubiquitous Veco 19 or Fuji (which I happen to have looking for a good home) involve a little, a very little, filing down of the side walls of the moulded blocks. It only took me a few minutes with a side miller on the Unimat's flexible drive — a file would do the job equally well. Ready drilled holes in the chassis and in the two white metal mounts fit the Veco or Fuji and doubtless other motors.

Car with all in place (less silencer and heatsink).

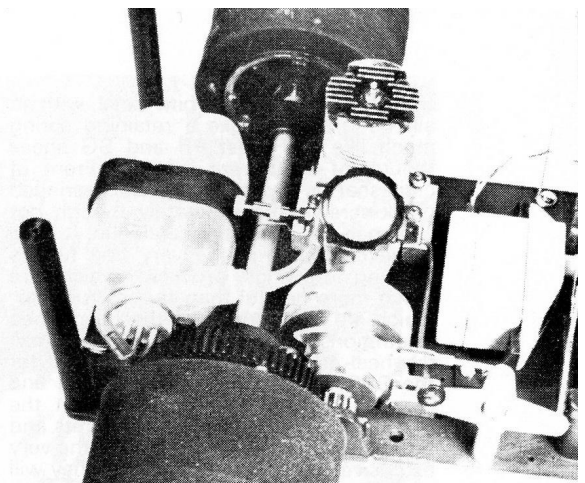

Rear end set-up showing radio box cutaway. Curious double fail-safes on steering.

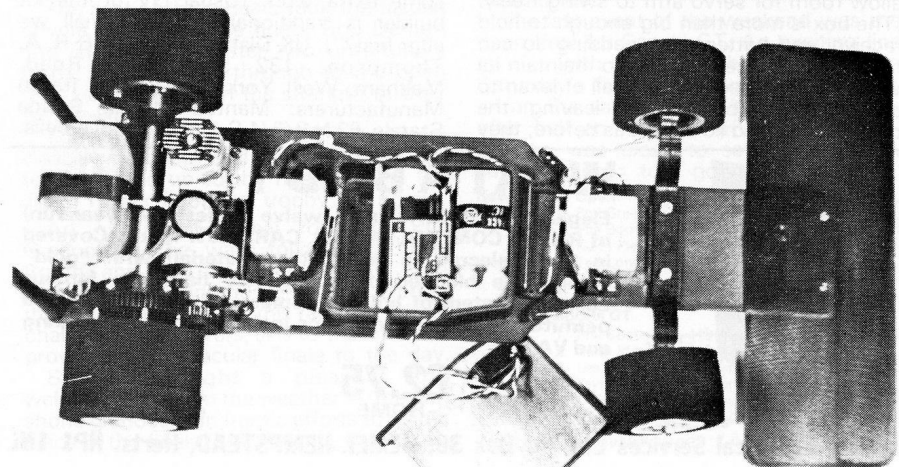
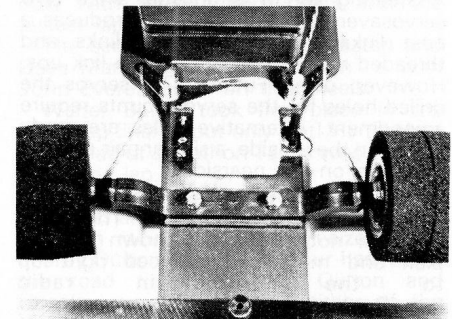

Clutch shoes are of white metal, with an all round slot to take a retaining spring much like the latest PB and SG shoes though of a different material. Front of crankshaft is supported in a ballbearing block screwed on separately though not shown in the illustrated catalogue. It does however appear in the very fine fullsize working drawings provided which are much more helpful than the instructions, which are really no more than captioned illustrations of progress stages. The small flywheel cone provided and intended for the OPS engine did not fit my Fuji and required machining down to fit on the crankshaft. Alternative motor mounts and some adapters are listed amongst the very extensive spares shown: whether they will be extensively carried here I do not know. Anyway many model shops, craft teachers etc would soon produce or modify cones for the builder, or so I trust.

Fuel tank is clear plastic and is fitted behind the axle with a rubber strap fixing rather like some of the stock car set ups. There is certainly no room in front for it!

Steering set up is unusual since two servosavers are fitted, but it produces a neat linkage. Excellent quick-links and threaded rod is provided for the link ups. However, using Futaba 17M servos the drilled holes for the servo mounts require amendment. Alternative holes are ready drilled on the off side, a similar pair need to be made on the nearside.

Set-up for throttle/brake linkage requires even more changes. The servo just will not fit where shown on the plan and must be advanced right up to the moulded-in radio box. Rear of this must be cut away to allow room for servo arm to swing freely. (The box is more than big enough to hold receiver and battery plus padding so can happily be reduced in size. To maintain its usefulness I added a cross wall of lexan to complete the box again, leaving the original sides and lid almost as before; they

could be cut away. No suitable hole had been drilled to take the rear throttle/brake set-up. Plan shows it correctly placed and a pair of dividers was used to scribe its exact location in the chassis plate: an appropriate hole was then drilled. Again adequate and elegant quick-links are provided.

Brake set-up is a very fine brass quadrant set in a brass block which screws onto the chassis. Shoe is of rubber. Braking action is straight forward push for "on" without any spring tension. An alternative spring-loaded version can be obtained the instructions say.

With rear location of a plastic tank any form of stand up dustbin type silencer is not possible. But the latest Fuji includes what seems a very adequate silencer which can if need be used to operate a pressured fuel tank so I fitted that. It has not been tested by me for noise level so is installed hopefully . . . Flat type heatsink will be fitted but is not in place as it would obstruct my photos.

Body to be used will be a bright red ready coloured Sports/GT from SG reputedly Ferrari or a fairly near relation . . . it suits the kit body mounts. Also to be fitted — especially in view of rear and fragile fuel tank is a small rear bumper. Front bumper also of nylon fibreglass is adequate.

So there it is. Intended, I think, very much as a beginners' kit. I am not sure that it falls precisely into that slot since using the more available British accessories involves a fair number of changes in layout. Local Italian/European bits and pieces may be more suitable. But I liked it when I first saw it; now that I have made it up I still like it and enjoyed the need for some extra work (Usual cry of the kit builder is traditionally: "What shall we alter first?"). UK Distributors: C. I. & R. A. Thompson, 132 Slaithwaite Road, Meltham, West Yorks, HD7 3PW. Italian Manufacturers: Mantua Model, Strada Statale, 62 N.2/3/4 S. Lucia di Roverbella.



WELSH GRAND PRIX

IT was with just a little trepidation that Race Director Ray Moffatt and host club Wrexham held their first national meeting at Hoseley Circuit on the weekend of July 8th and 9th. This was the first real test for what is, at least for model cars, a revolutionary new track surface called 'Mileseal'. Mileseal is laid with sweeping brushes believe it or not. Fortunately all fears were unfounded and most of the visiting competitors commented on a superb weekend's racing, — well organised, in an attractive wooded setting.

Saturday dawned somewhat cloudy and overcast, but rain held off until the last ten minutes of the final event of the day.

The best of three heats took the fastest drivers through to the finals. Bob Denton and Steve White, after two unfortunate heats, both made it through to the open final via the semi, on the strength of their third heat.

The handicap final followed with drivers closely matched and providing an interesting lead up to the final — local lad John Turner kept the trophy 'at home'.

An exciting F1 final followed. Phil Greeno led the way, followed by Phil Booth and Keith Plested closely contesting for second and third place. During the last ten minutes of this race the drizzle challenged the drivers, skill to the limit and provided a spectacular finale to the day.

Sunday brought a pleasant and welcome change in the weather — the sun shone gloriously on frantic efforts to gain a place in the finals. Phil Greeno, true to his

form of the previous day, showed them how with three superb heats and the fastest lap time.

The semi-final gave Keith Plested and Dave Martin places in the open — with John Everett close on their heels.

Walter Bailey took first place in the handicap final — but only just! He finished just ahead of Jonathon Taylor who was on the same lap.

(Jonathon is a local youngster whose dad mechaniced for him that weekend in between racing his own full-size car at nearby Oulton Park, — rumour has it that the road times between Oulton and Hoseley were faster than either of the track times.)

The last event of the weekend was the open final for Sports GT. An exciting line up — with four of the drivers from Saturday's final. Phil Booth won the day — on the same lap as Keith Plested — after half an hour of driving. The competition was close to say the least. A suitable climax to a good weekend.

Results	F1 Open	Handicap
1.	Phil Greeno 93 laps	J. Turner
2.	Phil Booth 89 laps	A. Micklethwaite
3.	Keith Plested 89 laps	J. Taylor
4.	Ted Longshaw 82 laps	J. Anderson
5.	Bob Denton 80 laps	B. Palmer
6.	Steve White 78 laps	F. Martin
Sports GT		
1.	Phil Booth 113 laps	W. Bailey
2.	Keith Plested 113 laps	J. Taylor
3.	Les Wheldon 105 laps	D. Jones
4.	Dave Martin 101 laps	C. Brearton
5.	Steve White 81 laps	A. Micklethwaite
6.	Phil Greeno 61 laps	B. Webster

Report by Margaret Livesey

Sent direct by Easibind. Allow 2/3 weeks for delivery

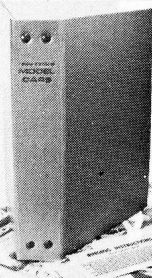

WHAT A BIND !

Elegant BINDERS to take twelve copies (two year run) of RADIO CONTROL MODEL CARS now ready. Covered in Red Balacron (a leather-like material) with "gold" colour title blocked on spine they have the famous Easibind system of holding copies without damage and permitting easy removal. Price includes postage, packing and VAT.

£2.75
HOME

£3.25
OVERSEAS

L-D Editorial & Technical Services Ltd. PO Box 30. HEMEL HEMPSTEAD, Herts. HP1 1NI

NEW ASSOCIATED RC 200 KIT

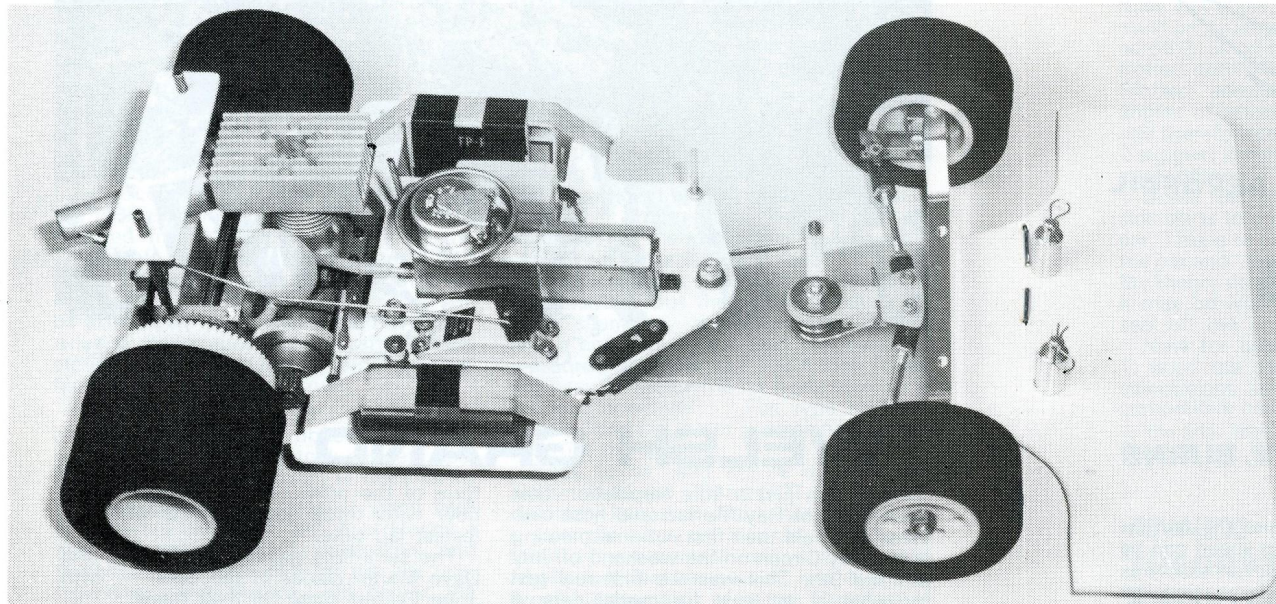

NEW FEATURES

Aluminium Front End
 New Servo Saver
 Ball Joint Tie Rod
 Fibreglass Chassis
 Disc Brake
 8mm Rear Axle
 New Rear Pod Plate
 New Gear Material
 Plus Fuel Tank

PROTOTYPE RC200 CARS WERE USED BY WORLD CHAMPION, BUTCH KROELLS, AS WELL AS THE FIRST 7 PLACE FINISHERS AT THE WORLD CHAMPIONSHIPS.

1977 EUROPEAN CHAMPIONSHIPS



PER GUSTAFSSON— SWEDEN
 SPORTS CHAMPION



UDO FRANKE SWITZERLAND
 FORMULA CHAMPION

1977 USA ROAR NATIONALS



ROGER CURTIS
 SPORTS CHAMPION



BILL JIANAS
 G.T. CHAMPION

1978 BRITISH G.P.



DEBBIE PRESTON

1st BRITISH G.P. Sp/GT
 2nd WORLD CUP MONACO
 3rd EURO. CHAMPS Sp/GT

ASSOCIATED 1928 East Edinger, Santa Ana, CA. 92705, USA

Scale: Approx full size. Slots between sections of aerofoils to be approx 1-16th inch.

FIG 1

FRONT AEROFOIL

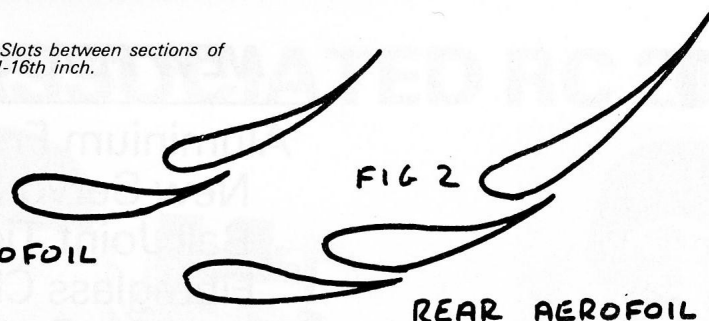

REAR AEROFOIL

WING AEROFOILS

AERODYNAMICS IS IT WORTH IT?

OR AERODYNAMIC DOWNTHRUST

ASSISTED CORNERING

By R. T. BURNS

One of the major technical talking points in full size Formula One racing is the use of aerofoils and other aerodynamic ploys to press the cars harder onto the track in order to be able to corner faster. Is it worthwhile doing this on RC Model Cars? The short answer is yes for large radius curves (say 30ft radius or more) but not really for short tracks with sharp corners.

To be any use the aerofoils should be as large as the rules permit and be an effective low speed section to obtain the maximum lift coefficient. They will increase the aerodynamic drag on the car, but if the overall design of wings and body is done correctly (look at the latest Lotus) the drag penalty should not be too great.

Those of you who wish to check my theory may turn to the Annex at the end of this article. For the remainder I will try to simplify the theory.

For a car to travel a circular path, a force is required acting on the car towards the centre of the circle. This is called the centripetal force and comes from the friction between the track and the tyres. For a given radius of circle, the magnitude of the required force is proportional to the weight of the car and the square of its speed. If the speed is doubled the required force increases by a factor of four. It is easy to reach a speed that requires a sideforce that the tyres cannot provide and the car slides or spins off.

The maximum available sideforce is proportional to the coefficient of friction

between track and tyres and the vertical load on the tyres. Cornering speed can be increased if the vertical load on the tyres can be increased without increasing the weight of the car. Fitting upside down aerofoils to the car does just this.

Aerodynamic force is proportional to the square of speed so that the aerofoils will have very little effect on slow corners but will become more effective as corner radii increase and cars will be travelling faster. A car with effective aerofoils will have three advantages over other cars:

1. It can go faster round large radius curves.
2. It can enter fast curves faster and because the downthrust enables harder braking to be used it can brake for a curve much later — a great advantage for overtaking.
3. It leaves a curve much faster and thereby more rapidly reaches maximum speed on the next straight.

There is a disadvantage. If the car slides there is a sharp drop in downthrust making the slide more difficult to control. To drive fast you must be very tidy, no tail-hanging.

Now to the practical side. The wings should be as far from the rest of the car as possible, and there must be no part of the car over or under them. Supports must be the minimum consistent with strength. In practice, the front wing need be no more than about four inches in front of the front

axle, but it must be strong enough to act also as the front bumper. The rear wing must be as far back and as high as the rules will allow. Side dams or end plates must be as large as allowable. Use slotted aerofoils as on the real cars. In fact double slotted aerofoils can be used at the rear. Slotted aerofoils can work at greater angles of attack than unslotted aerofoils and therefore generally more lift. Figs 1 and 2 suggest aerofoils sections that might be appropriate.

Some real F1 cars are now fitted with side skirts to prevent air flowing under the car. This is to create a low pressure under the car and "suck" it down onto the track. My theory does not include this effect, but it may be worth trying. You will need to seal off the underside of the chassis.

Now for two important points:

1. Build the car as light as possible. My calculations assume that anyone who is competitive has built his (or her) car down to the 5lbs limit. The rules limit the size of aerofoils, so keep the weight down.

2. Use tyres with the highest coefficient of friction. This enables the car to corner faster in the first place so that aerofoils have even more effect.

The table at the end of the Annex shows the effect of lift and friction coefficients on cornering speeds. The columns headed C-O are for no aerodynamic downthrust. A lift coefficient of 2.2 may be optimistic, but a good low speed slotted aerofoil should be able to get near it.

One thing I have not considered is the balance between the downthrusts on the front and rear wings. The handling of the car may change as speeds increase — i.e. it may change from understeer in a slow corner to oversteer in a fast curve. This is because the front aerofoil is in a relatively undisturbed airflow and could generate more downthrust than you want for good handling. It may be necessary to move the car's centre of gravity forward to extract the maximum benefit from the aerofoils, or possibly fit adjustable aerofoils to trim out the effect.

ANNEX THEORY OF AERODYNAMIC DOWNTHRUST ASSISTED CORNERING

Notation: W = Weight of Car = 5 lb.
g = acceleration due to gravity = 32.2 ft./sec.²
u = Coefficient of friction between track and tyres
c = Coefficient of lift on aerofoil
v = Speed of car
r = radius of circle
p = density of air = .00238 Slugs/Cubic foot
s = total wing area = 42 sq. ins. = .2917 sq. ft.

I am working in Imperial units. I last did aerodynamics in 1962 before the great metric revolution.

Total downforce on tyres = $W + \frac{1}{2} PV^2 SC$
= $W + KC V^2$

where $K = \frac{1}{2} p S$
therefore maximum available sideforce = $u(W + KC V^2)$
At speed of v round a radius of r, the required centripetal force is $\frac{W V^2}{g r}$

So that the maximum speed is obtained when

$$\frac{W V^2}{g r} = u(W + KC V^2)$$

or

$$V = \frac{\sqrt{uW}}{\frac{W}{g r} - uKC} \text{ ft./sec.}$$

Inserting values:

$$V = \sqrt{\frac{5u}{32.2r} - .0003471 uC} \text{ ft./sec.}$$

See following table for some values of v.

STEADY STATE CORNERING SPEEDS, FEET/SECOND

r ft	u = 0.7			u = 0.9			u = 1.0		
	C = 0	C = 1.5	C = 2.2	C = 0	C = 1.5	C = 2.2	C = 0	C = 1.5	C = 2.2
2.0	6.71	6.73	6.74	7.61	7.64	7.65	8.02	8.05	8.06
2.8	7.96	7.98	8.00	9.02	9.06	9.08	9.51	9.56	9.58
4.0	9.43	9.48	9.50	10.70	10.76	10.79	11.28	11.35	11.39
5.5	11.18	11.26	11.29	12.68	12.79	12.84	13.37	13.49	13.55
7.8	13.26	13.38	13.44	15.03	15.21	15.30	15.84	16.06	16.16
11.0	15.71	15.92	16.02	17.82	18.12	18.27	18.78	19.14	19.31
15.4	18.63	18.97	19.14	21.12	21.63	21.88	22.26	22.86	23.16
21.6	22.08	22.66	22.95	25.04	25.89	26.33	26.39	27.40	27.92
30.4	26.17	27.16	27.66	29.67	31.14	31.90	31.28	33.01	33.92
42.7	31.02	32.71	33.59	35.18	37.69	39.06	37.08	40.06	41.72
60.0	36.77	39.67	41.28	41.70	46.08	48.66	43.96	49.18	52.35

SHOPPING AROUND

Recent special electric car feature in our friendly neighbourhood magazine *Radio Control Models and Electronics* has I learn produced a spate of new customers — one model shop reckoned to have sold about twenty five cars (in bits of course) as a consequence. Bill Burkinshaw tells me he still has some of the specially prepared 1/20th scale speed control printed circuit boards left. These come with PCB, resistance wire and instructions for £2.00 from MAP at PO Box 35, Hemel Hempstead. They also suit most scratch built vehicles 1/20, 1/16th or similar scales, using three forward speeds plus dynamic braking and reverse. Another electronic gimmick that has come my way is the Lightning Models' voltage regulator kit, specially useful for forgetful charging people, since it will drop up to 20v D.C. down to 5v, a great help if receiver left in circuit when charging.

At this stage of the season many glowplug engine fanciers must be running short of engine supplies. OPS I gather are in quite short supply but stocks promised imminently: plenty of K & B 21s around — the aircraft variety selling at £39.95 (i.e. without the car carb) seem a good way of filling the need less expensively. Other goodies are the improved AMPS diff now selling at £49.95 including mods learned from racing experience — the main one being more adhesive screws which now

Rick Davis's Veco powered Porsche complete with detailed dash, driver, etc. A real concours car. Seen at Weak Signals Show, Toledo, U.S.A.

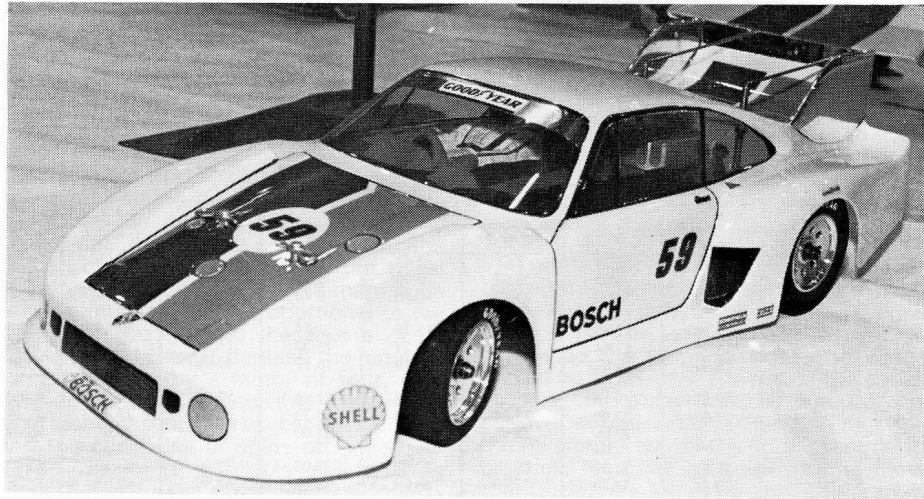

do **not** have that tendency to shake loose. Keith Plested's PB diff. sells at only £28.00 and fits direct on to the existing PB International rear end. This one has spur gears and not bevels. Keith has been not only winning and placing well this season (where there is an element of luck — good or bad) but consistently clocking up FTD in both Formula and Sports/GT Classes at meetings both at home and abroad. Other of his new items include GRP chassis for the International, new air filters with special dirt resisting packing now in production, plus his latest pattern slide carbs to come very shortly. Irvine Engines are now putting out their own 20RC car and have also been distributing the latest HB21 engine which promises well.

Big news for electric car fans must be release of the Associated RC12E electric car which so impressed at the Toy Fair. With their successful glowplug range of kits one is apt to forget that their company title is Associated **Electric** and that this is their original market. The claim with the new car that it is "designed from the ground up as an electric car, not a converted gas car". This has not prevented them, however, using some of the more desirable attributes of big brother car such as a radio tray. The whole set-up looks extremely interesting, with such features precision ground round steel axle which makes it possible without much trouble to fit ball bearings. Price promises to be competitive, not firm fixed yet, but under £40 is the expectation. One of my favourite

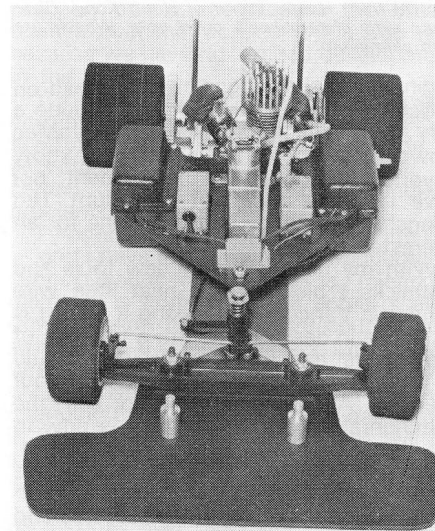

JoMac 1/8th scale kit car. Note inverted servos and nice plastic boxes for radio gear. Exhaust manifold for K & B21, also from Toledo. Bending jig. To be screwed down on bench — very useful. JoMac's bodyshell for Renault. Clear or coloured.

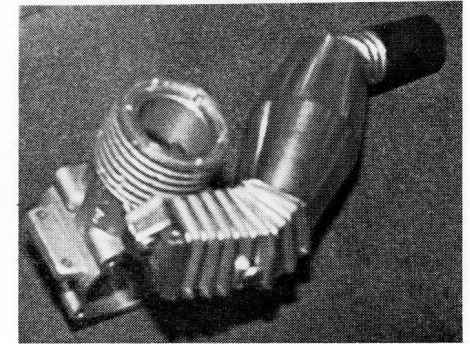

fullsize racing cars is now in 1/12th bodyshell — the Renault Formula 1. It is also being done in 1/8th scale, both by JoMac Products Inc. Both bodies come ready painted and include wing; or less expensive versions in clear also available. American prices run from 1/12th clear at \$11.00 upwards, so probable UK price can be judged at between £8/£10. This seems a lot but the Lexan bodies seem to last forever, particularly with electrics which live a more cushioned life. My Ferrari body now over a year old has been hit by all the best people and only just

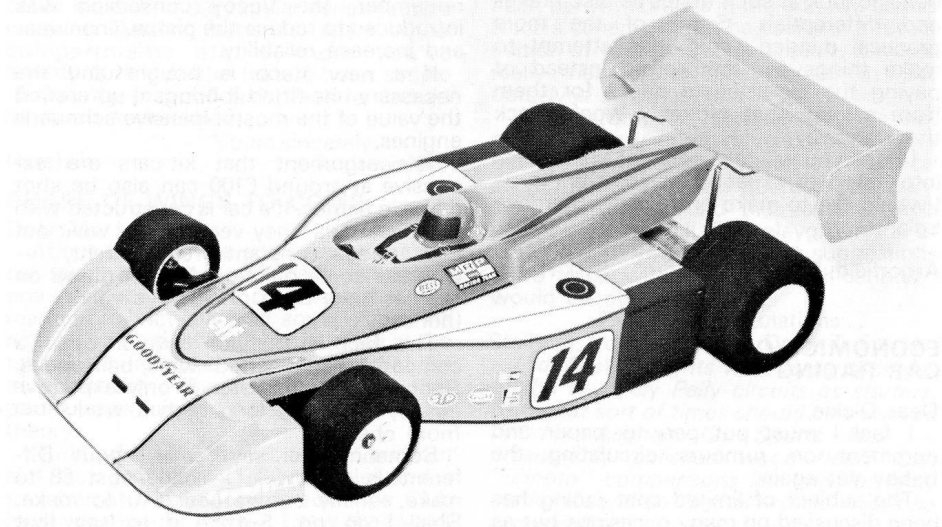
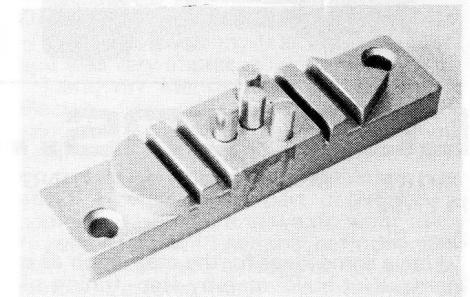

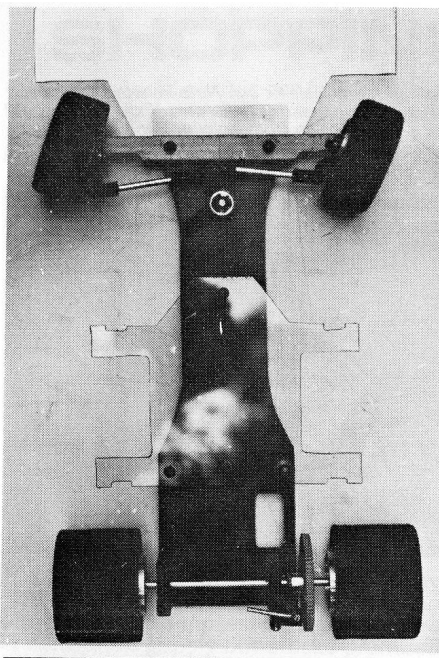

AKS 78 from *Hobby World of Hong Kong*. Clear Lexan radio plate strikes a novel note. Wheels are spun aluminium.

'beginning to show signs of wear (dead-on collisions wear out anything!). I include a very attractive picture of the JoMac glowplug 1/8th scale car. I do not know anyone importing it at the moment, nor have I had a price but no doubt Ted Longshaw could lay hands on one for an interested party!

With my usual zest for new tools and gimmicks I picked up a neat little wire bender in Vancouver. Looking it over it is so simple in design that with a few bits of scrap metal and good hacksaw it should be possible to knock up a copy on a cool evening. Also I was glad to see the continental style of rotary rasp is now in the shops for both wood and metal use. Mine hails from Italy under the make name of Vitrex and cost 80p. at Buck and Ryan a week or two ago. "It drills, mills, files and shapes" it says on the card.

The US Toledo show produced its usual spate of new ideas, mainly aircraft, but the K & B manifold pictured here struck me as something a little bit different.

LETTERS...

'MORE SCRATCH BUILDING PLEASE!

Dear Sir,

I have some ideas for the mag, such as a Mardave kit build, step-by-step- tuning of both chassis and engine, and a more detailed look at such things as disc brakes and differentials. Some of the more practical minded could then attempt to make things for themselves instead of paying the extortionate prices for them from a shop that probably won't stock them anyway.

I hope you will take some of these ideas into your may, especially the disc brake, as I would like to make one for my Mardave Lola.

Arborfield, Berks.

Yours faithfully,
S. J. Harris

ECONOMICS OF R/C CAR RACING

Dear Dickie,

I feel I must put pen to paper and comment on rumours circulating the hobby yet again.

The subject of limited cost racing has been discussed on many occasions but as

a scratch builder of model cars it will probably affect us the most. The matter of engines comes up first. Several drivers are of the opinion that the purchase price and type of engine should be limited. I certainly don't want to have to buy a piston and liner every weekend — and if you remember, the Vecoy conversion was introduced to reduce the piston/liner wear and increase reliability.

If a new Vecoy is bought and the necessary bits fitted it brings it up around the value of the most expensive schnuerle engines.

The argument that kit-cars are expensive at around £100 can also be shot down in flames. If a car is constructed with plain bearings, they very quickly wear out and need constant replacement, — whereas some of the ball races fitted on my car have been on for five years. (honestly).

The fact is that to buy or build a competitive car fitted with ball races, Schnuerle engines etc., is only expensive initially — in the long term it works out more cheaply.

Someone will say 'what about Differentials etc.' well, — mine cost £8 to make, — my engine cost £10 to make. Shall I go on. Suffice it to say that

probably one of the reasons the British team won at the Monaco World Cup was because we have not limited development in this country.

Yet again the question of expensive nitro-methane rears its head. Personally I feel that only a total ban — worldwide, is acceptable. Trying to limit its use to certain quantities would cause endless problems.

Tyres are yet another sore point with me — and I have raised my voice frequently. I cannot understand why the minimum diameter is more than the actual scaled down version of its full size counterpart. Are we not 1/8 scale modellers. Most of the tyres we use are giving the best handling characteristics just at the point we are changing to stay legal. Rumour has it that in full size Formula 1 racing tyres will be strips of rubber by the end of the current season.

There will without doubt be many more discussions over the years — and I think on the whole it's good for the hobby, at least it gives us the opportunity to say 'British is Best' for a change.

If matters are not discussed and the full facts made known — there is always the danger of decisions being made and changes in the rules which will — in retrospect — appear wrong.

Yours faithfully
F. J. LIVESEY

Northwich, Cheshire

MORE STARTERS

Dear Editor,

I was wondering whether you might be able to do a step-by-step build up of a Starter-Box in the mag some time. You could make it into a regular series feature covering starters, batteries, spare wheel compartments etc. I know you've already done a starter feature but a simple "follow-the-instructions" feature would be much appreciated.

Yours sincerely,
Andrew Allen

SHAPE OF WINGS TO COME

Dear Mr. L-D,

About two months ago I saw some r/c car racing for the first time. I overheard one of the modellers comment that the rear aerofoil actually had some effect. As an ex-aeronautical engineer I looked at the tatty flat thing called an aerofoil and at the comparatively sharp corners on that particular circuit and decided to check the theory.

During the 1960s I was an out and out slot racing nutcase (1/32nd scale) and a member of the famous Brooklands Club (well we thought it was). I saw that sport

become more and more costly to the point where it stopped being fun. I can see r/c racing cars going the same way. Unfortunately I cannot see a simple way of keeping the costs down. Stock car racing formula achieves this to a point but penalises the skilled craftsman who can build superb cars at a very low capital outlay by requiring him to be able to supply others with replicas of his models within the price limits. A formula is required that creates competition based on driving and building skill but removes the bias of wealth. In slot cars, an early ban on sponge tyres and tyre dressings and on silicone rubber tyres might have had the right effect, since it was the fancy tyres that allowed the use of powerful and costly motors.

Success to your magazine
R. T. Burns
Andover
(Ed: Mr. Burns' article on Wings should set some builders thinking).

SUGGESTIONS WANTED FOR A CIRCUIT LAYOUT.

Dear Mr. L-D,

I have just read my first copy of RCMC and was very impressed with its contents.

I and my friends have just began RC Electric Car driving. We are gaining enough competence to begin racing our Lectricars against each other before going on to try our luck in competitions further afield. However, our part of Norfolk is somewhat isolated and we do want to try to keep apace with national performances. Can you therefore suggest a suitable shape/size for a track and the times we will need to achieve per lap to put us on, or near, par with drivers in more active areas? Such a scheme might be useful in a future edition of your magazine because it would really help other backwoodsmen like ourselves in other rural areas.

Apart from the disadvantage of not meeting many other drivers we do have definite advantages. I teach at the local school and we have a 100m x 20m pancake flat playground plus access to a gigantic sports hall. The playground is of asphalt, so if you could make suggestions for a track within those specifications I would be obliged.

Finally, congratulations.
Stalham, Norfolk. Derek T. Farman

(Ed: First thoughts were to send copies of the two Ally Pally circuits as starters. But what sort of times should be achieved on (1) Asphalt (2) Sports Hall — presumably polished wood floor? Can "remote" comparisons like this be fairly made? If so, then "postal racing" might be a possibility!)

PAINTING LEXAN BODIES

In our article under the above title last issue on page 20, just below heading "The Paint" some words were omitted giving an entirely wrong sense to that paragraph! The ordinary cellulose aerosol spray as used for touching up full-size cars and painting Butyrate shells should NOT be used on Lexan! It will have sad effects! If you have any doubts as to suitability of paint try a little on an offcut from trimming the body first.

ANOTHER CONVERT . .

Dear Sir,

With eleven years of model boats behind me I am now an r/c car nut. I would like to see an article on body preparation and finishing. My own ideas are as follows:

(1) Cutting out Lexan materials use a heated knife for main cutouts and heated 1/4 in. dia. rod for holes. Cutting ABS no need to heat knife. Drill holes.

(2) Double up weak point around bodymounting holes with 1 in. x 1 1/2 in. piece of ABS or Lexan, pop rivetted underneath.

(3) Rub down ABS shells outside with very fine wet/dry paper, wash with washing up liquid. Rub down Lexan shells inside with fine wet/dry paper. At this point the shell goes grey and you wonder if it's kaput! It will be okay — wash with washing up liquid again.

(4) Humbrol spray enamel works well with ABS (no need to fuel proof) Humbrol small tins still very cheap. Brush on enamel works very well with Lexan.

(5) Using PVC insulation tape of contrasting colour (wide or narrow) makes a good racing stripe, breaking at air intakes, windscreen etc. I cut it on the body the cut won't show.

(6) Apply decals — when dry cut suitable overlay in clear Fablon material self

adhesive. Narrow border only needed.

Pet hate! To see pure white unpainted driver/ABS car things going round the track.

Keep up the good work.

Yours etc.

High Wycombe

D. W. Faulkner

Maidenhead Model Makers Club member.

THE MIXTURE AS BEFORE . .

Dear Mr. L-D,

Out of curiosity at the recent Swiss EFRA Trophy Race, I asked some of the competitors which oil they used, and how much. One or two competitors seemed surprised at my implication that their motor used oil; one or two seemed not to recall which motor they were using, never mind which oil. Some produced a one-litre bottle of *modellflugbenzin*, scratched their heads and pointed out that the label didn't seem to say. One competitor used 10% castor oil, another 3% (when I swept up the pits after the race I found some broken bits of K & B 21). An Austrian competitor, apparently misunderstanding the question, supplied the interesting gem that he gradually increased the percentage of nitromethane as the motor got older, in order to maintain the effective compression at that selected by the K & B Mfg. Corp. With regard to the experts, they knew exactly what they were using. The Britons and Monagasques used 10% Castrol 98 (a synthetic oil); the Austrians use 10-15% of an unspecified synthetic oil; Udo Franke uses 10% of his home-brewed synthetic oil; while the other Swiss are back to 20% of your actual first pressing Castor Oil. Incidentally, I was the starter, waving a socking great Geneva flag all week end, and my wrists don't work any more.

Rex Watson

(Ed: You should see the pretty Christmas Tree lights at Lilford Park that take all the sweat — and some of the fun? — out of starting, Rex!).

SPEED BUILT

MANUFACTURED BY O.K. MODEL CO., LTD.

1/12th SCALE

radio

control

car for

.099

GLOWPLUG ENGINE

lamborghini countach LP400

1. Forward **AND REVERSE** with engine speed control
2. Transmission gear box with nylon motor gears clutch & rear suspension ready installed
3. One piece all diecast metal chassis
4. Fuel tank built in to the die cast chassis
5. Four wheel independent suspension
6. Fan cooled engine with formed plastic cover

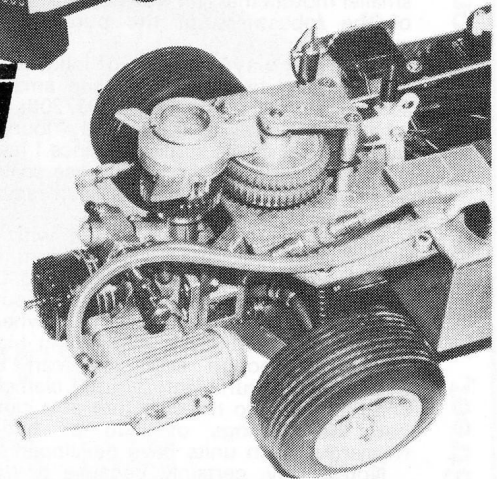
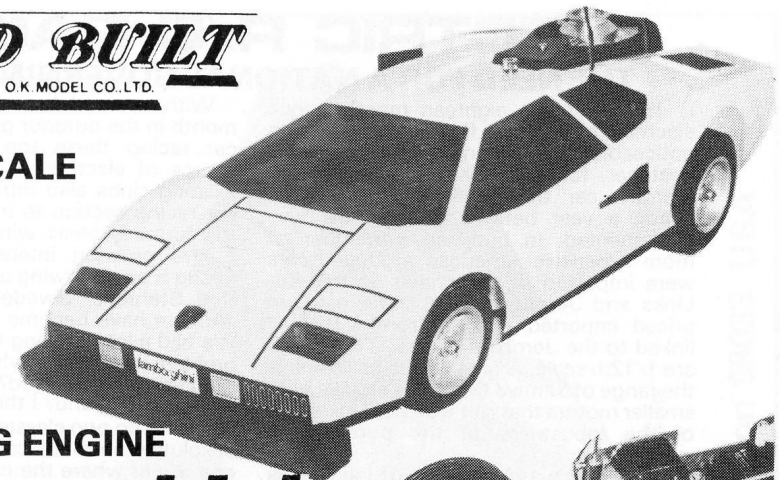

The Lamborghini is suitable for any of the .099 engines, which fit diecast motor mount on chassis. All you need add is engine, silencer and radio gear including servos. Suitable for any good 2-channel outfit.

Ready formed body is already coloured.

PRICE Lamborghini (as illustrated)
£47.50

Also available: Ferrari GT 4 BB (Very much more detailed body).
PRICE **£52.50**

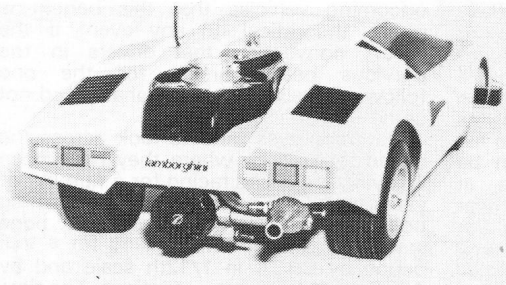

I & D ELECTRONIC CO'S "SMOOTH TRONIC"

Electric Car Speed Controller with Proportional Throttle and Proportional Dynamic Braking

VERY WIDE RANGE OF ENGINE SPEEDS — for precise control over all manoeuvres (e.g. smooth handling through corners). **FULLY PROPORTIONAL DYNAMIC BRAKING** — giving a smooth transition from full power, down through "neutral" to maximum braking. **PLUGS DIRECTLY INTO RECEIVER** (positive 1 m/s-2 m/s) for elimination of servo, push rods, complicated wiring, unreliable switches and hot resistors. **PERSONALISING ADJUSTMENT** — The position of the TX stick at full throttle, neutral and braking is pre-set by 2 small adjustments. **SMALL SIZE** — (1.6 x 2.4 x 0.9in) — for quick and easy installation. **LIGHT-WEIGHT** (2 oz.) — for maximum acceleration. **HIGH POWER CAPACITY** — for 7.2 volts, 12 amps (25 amps peak). **ONLY 0.2 VOLT DROP AT FULL POWER** — ensuring no reduction in performance in acceleration and top speed. **LOW POWER CONSUMPTION** — for very cool running, and more power available at the wheels towards the end of the race. Send cheque or postal order to:

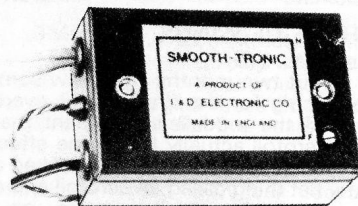

PRICE: **£26.83** (Inc. VAT + p/p)

(overseas: **£24.35**, inclusive)

(Trade enquiries welcomed)

I & D ELECTRONIC CO. 46 Church Road, Barnes, London SW13, England Tel. 01-741 0333

IRVINE ENGINES

UNIT 8, ALSTON WORKS, ALSTON ROAD,
HIGH BARNET, HERTS. Tel: 01-440 0923.

ELECTRIC R/C RACING

THE NEED FOR A NATIONAL GOVERNING BODY

IT IS now some eighteen months since electric r/c car racing first began to make a noticeable impression. First came the Lectricar, followed by the promise of a Mardave car, though in fact it was to be nearly a year before that promise was implemented. In between a number of more expensive American produced cars were imported in the shape of the Bo-Links and Jerobees; plus some medium priced imported models from MRP, all linked to the Jerobee chassis. These cars are 1/12th scale. A final 1/12th scale link is the range of Tamiya fine scale models with smaller motors that run well but lack some of the robustness of the pure racing machines.

In a minor way a number of individuals and some clubs have embraced smaller scales such as 1/16th and even 1/20th for what has come to be called "lounge racing." This is not surprising since I hear of quite amazing progress in these scales from Japan where numerous such racing clubs are thriving.

Virtually any town or village with a decent sized village hall, gymnasium or similar smooth floor area that could be hired on reasonably low terms (this puts out of court many school halls where grasping bureaucracy is demanding high rentals — though even this can be overcome if a sufficient "youth" element can be built in to the structure of a club) had the makings of club at hand. Numerous such units have developed.

Noteworthy, certainly because it was the first to be widely known and had the largest floor area at that time, was the group meeting at Alexandra Palace and running on the speed skating rink. This group crystallized into the Ally Pally Electric Car Club, of which I am happy to be a member, and after such vicissitudes as the roof caving in has now established a regular almost weekly meeting with an attendance of about 50 per cent of its membership at most evenings so that a full house 32-entry race programme can be run with 8-car heats. Meanwhile at Leicester — the home of both Lectricar and Mardave — a Midland Electric Car Racing Association was formed, in effect a loosely knit group with regular meetings — now grown to twice weekly — at Wolvey and Countesthorpe College. These venues though attractive with good seating, refreshment facilities and so on, offer very much smaller racing areas than enjoyed at the Palace.

With new clubs springing up every month in the outdoor glowplug side of r/c car racing these too provided a new source of electric car enthusiasts; many existing clubs also introduced an electric car racing section to interest members in the formerly bleak winter season.

This growing interest in electric car racing is also showing up on the continent. Rolf Stahre of Sweden writes: "Electric r/c cars have become very popular here. We had a lot of racing last winter, but the problem is: with what motor? What modifications allowed? What is the intention in England? I think we are going to divide it into two classes: one stock, where absolutely no modification is allowed and one Super where the car is the only thing regulated. What do you think? Of course the capacity of the batteries is maximised to 1.2v. per cell."

Just such a problem exists in England. The Ally Pally group with their large racing area; and Maidenhead who have very much the same sort of size with a rather more modern ambience are all for the more expensive Jerobee cars and their derivatives, including some very interesting scratchbuilds and mods to existing equipment. The American cars normally do not have a reverse facility, though nearly everything else. The Midland group with their smaller halls and adherence to Mardave and Lectricar are hankering after a set of rules that makes a reverse mandatory. This would theoretically ease the number of marshals required at a meeting. Against this the Ally Pally people say that so much damage, frustration and hold-ups are caused by cars backing out of obstructions and into oncoming vehicles that this benefit is purely theoretical. In any event if the BRCA convention that drivers in the previous heat marshal for the one following availability of marshals need not come into it.

Naturally eyes tend to look across the ocean to America where they have been enjoying organised racing for a number of years under the banner of their governing body ROAR. ROAR Rules have been tentatively adopted in England for a trial period by BRCA in 1/12th scale and by Ally Pally for their own meetings. The time now approaches when some national get together of the various units interested must be set in motion. Obviously the senior parent body of r/c racing British Radio Car Association, who are founder

JoMac Products, manufacturers of Jerobee and MRP R/C Race Cars, is the largest and second oldest race car manufacturer in the world. Our cars and radios won more U.S. ROAR National events than all other makes combined. JoMac makes special radios for gas and electric race cars, electric (4 and 6 cell) and gas (A & B) 1/12 scale cars, 1/12 and 1/8 scale bodies, 1/8 scale race cars.



Products Inc.

For a complete colour catalogue send \$0.50US to

JoMac Products

12702 NE 124th Street, Kirkland Washington 98033 USA

members of the European Federation, EFRA, are the obvious people to take the initiative, except that they have so far taken little if any direct interest in the subject! Their main activity is glowplug power models in 1/8th scale and in this respect they perform an outstanding job. So far, I believe I am right in saying, they have a small sub-committee to consider 1/12th scale both for electric and power models. (Very little on the racing side has been done on this in the UK. . . only the various ARTR models that run as patio pets.)

It is very important indeed that national organisation gets established soon or splinter groups all over the country will be running their own thing with great difficulty in arranging contests with any but immediately neighbouring clubs, when we might well soon be thinking in terms of a National Championship Meeting, with probable valuable sponsorship from leading electrical and battery making companies.

Equally important is the Swedish intention of a two class division "stock" or standard cars and specials, or nothing barred cars. Objection here is that this would make racing too difficult. Not a bit or it! There is no reason why the two classes cannot race together, with an outright race winner and a class winner — which may sometimes even be the standard car! Alternatives include handicaps, such as BRCA run, with the better cars/drivers having to exceed the less expert by a given percentage (rather like golf or polo handicapping); or a straightforward slow car with a start and fast cars on the scratch line very much as done at Brooklands in the old days, or more recently for Vintage Car Club events at Silverstone and elsewhere. A further and quite amusing variant is to start the cars all together, but with the slower cars receiving a distance start, say in 20 yard units all round the circuit (for racing fans in the North, this is how harness racing starts are made as you may have seen).

One side of American electric car racing that has not been operated here, so far as I know, is the 4-cell instead of 6-cell car. US drivers seem to use the 4-cell car for junior and indoor racing and save the six-cell for outdoor events. Certainly outdoor racing has only recently been tried here. The Ally Pally Battersea Park races were highly enjoyable, with everybody "going flat out from start to finish," as one participant put it. For want of a hall some clubs are using school playgrounds and weekend empty car parks for racing and have been enjoying good sport, if a little hard on the

tyres (but outdoor quality tyres are available) I enjoyed running on hard tennis courts at Pontin's last autumn.

It may be the consensus opinion will be to adopt the ROAR rules more or less complete. It seems a good idea therefore to publish them so that the whole club can see for themselves what such a move could or would involve. Here they are; some items are of a general nature only and do not mean anything "All applicable ROAR general specifications apply" which saves repeating scale definitions etc Otherwise there is a great deal of sense in taking on rules that have proved their worth and lack of ambiguity over several seasons.

ROAR 1/12 ELECTRIC CARS

1. All applicable ROAR general specifications apply (see drawing and dimensions below)

2. Radio — any legally licensed transmitter is allowed. Transmitters under 100 MW may be used at the operator's risk of interference from higher powered transmitters (When practical Race Directors should attempt to place under and over 100MW Tx in separate heat races. Comparison of times or scores will determine winners. In case of frequency conflict, fixed frequency loses)

3. Chassis — any chassis is legal provided it complies with general specifications.

4. Control — In addition to normal steering and forward speed control, operation in "reverse" is recommended, but not mandatory.

5. Drive Motor — No rewind or modified motors allowed, including re-timed, balanced, epoxied or ball bearinged. Astro 05, Macbuchi RS54, Rowe-Mexico, Igarashi are allowed. Motor should be commercially available with a retail cost not to exceed -15 (This figure would have to be a matter of agreement, say, £10) Any new motors will have to be approved by rules committee (4 months?) prior to use.

6. Nicad battery cells, nominally rated at 1.2 volts are considered the standard unit of battery power for electric car rules. Other types of batteries, if used, must not exceed the nominal voltage rating of their category.

7. Cars will compete in separate categories depending on the number of cells or voltage used to drive the car.

(i) Indoor cars will be driven by a maximum of 4 cells or 4.8 volts nominal at the motor.

(ii) Outdoor cars will be driven by a maximum of 6 cells or 7.2v. nominal at the motor.

1/12 GENERAL

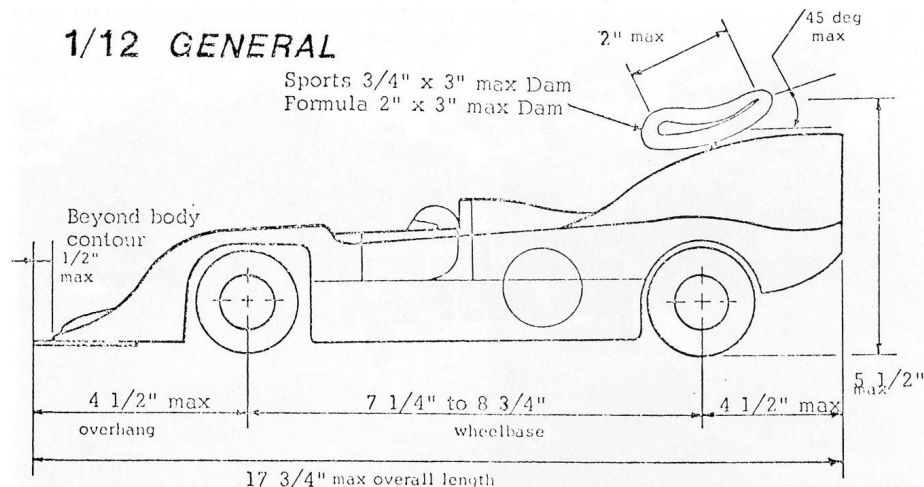

8. Race events should be of ample length (8 to 10 minutes) to further discourage motor modification. Batteries may not be **changed** during a race; though they can be **charged**.

General Specifications

Tyres: Tread width 1/2 inch minimum; 1 1/2 inch

maximum. Minimum diameter front 1 3/4 inch, rear 2 inch.

Overall width: 6 3/4 inch maximum includes body, bumper, wing & wheels Bumper: May extend 1/4 inch beyond side of body or to 6 3/4 inch whichever is less Wing: Width 6 3/4 inch maximum Chord 2 inch maximum Spoilers: Maximum spoiler height 1 inch Max length 1 inch.

Red Baron Models Ltd.

DO YOU DRIVE A S.G. CAR?

WE CARRY THE BIGGEST STOCK OF SPARES AND CARS IN UK
SPARES & KITS FOR LITTLE BIG CAR, COMP, PROFESSIONAL,
FUTURA, III

S.G. Little Big Car	£22.00	P.B. Std	£45.04	S/T Futura	£54.00
S.G. Competition	£50.00	International	£75.00	K & B 21	£47.50
S.G. Professional	£90.00	Mardave	£23.75	O.PS 21	£42.95
S.G. Futura III	£72.00	S/Tigre X21	£44.57		

International Glass Chassis £8.00 Amps Differential P.B. Differential

Large stock of tyres, silencers, air filters and motor spares

1/12 scale full range for Bolink Mardave, etc.

Speed Controllers, 1-2 Nicads £1.60 each

SAME DAY SERVICE!
JUST PHONE YOUR
NUMBER MAIL ORDER
HOBBYCARD, H.P.
TERMS, ALSO
AVAILABLE

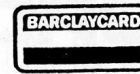
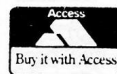

New, Red Band Motors very fast £7.00

497 HERTFORD ROAD, ENFIELD, MIDDLESEX

Late night Fri. 7 pm. Easy
parking
Tel. 01-804 7452

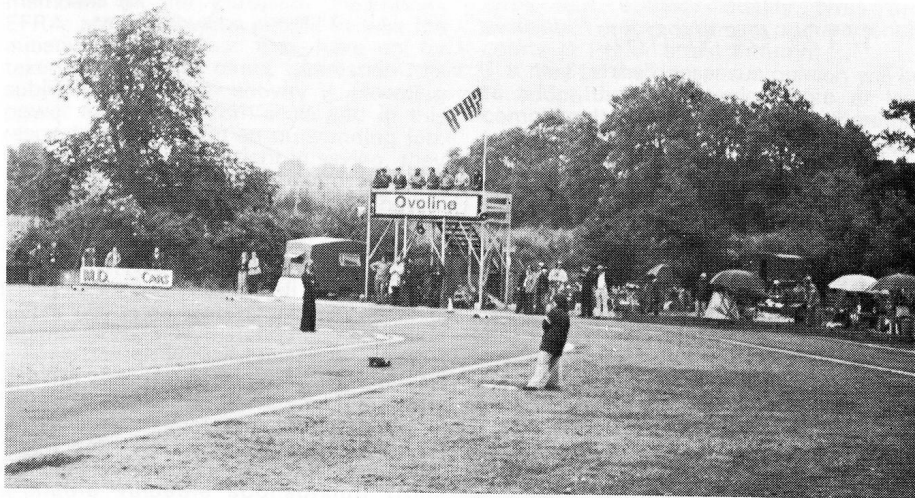

TIBSHELF 6 HR SAPA MARATHON

23rd JULY 1978

Seven teams took part in the event which started promptly at 12.00 noon in rather damp conditions which persisted throughout the day. The line up at the start was Tibshelf 'A' Bradford, Newbridge, Wombwell, Tameside and Tibshelf 'B'. These six got off to a good start with the London team starting 15 laps later. London were in trouble from the start, two of their team having broken down on the motorway and two having trouble with their cars from the start. The earlier rain had stopped and the track was beginning to dry out in a freshening breeze and after ½ hour the leading positions were Tibshelf 'A' and Bradford on 68 laps, Newbridge 55, Wombwell 51. The clear leaders after 1 hour were Tibshelf 'A' (221) by 8 laps from Bradford with Newbridge 3rd 192. After their poor start the London

Tibshelf in the rain, alas, at the SAPA Marathon meeting, Opposite: Mr Peter Jones of SAPA presents trophies to the winning team, Bradford.

TEAM	1/2 hr	1 hr	1 1/2 hrs	2 hrs	2 1/2 hrs	3 hrs	3 1/2 hrs	4 hrs	4 1/2 hrs	5 hrs	5 1/2 hrs	6 hrs
LONDON 1	18	85	153	218	253	273	290	Retired				
TIBSHELF 'B' 2	49	102	154	216	278	322	383	442	508	543	578	637
TAMESIDE 3	46	98	152	189	221	251	263	279	302	326	372	403
WOMBWELL 4	51	99	152	215	274	311	350	409	456	490	529	595
NEWBRIDGE 5	55	118	192	262	327	373	418	478	539	592	642	714
BRADFORD 6	68	145	213	290	366	425	475	540	620	692	750	827
TIBSHELF 'A' 7	68	151	221	285	352	404	451	500	579	625	687	769
		83	70	64	67	52	47	49	79	46	62	82

team were charging up through the field and after 1½ hours only two laps separated Tibshelf 'B' in 4th (154) place and Tameside (152). At 2 hours the lead had changed hands, Bradford (290) led from Tibshelf 'A' (285) followed by Newbridge (262) and London (218) who were steadily improving, Tibshelf 'B' (216), Wombwell (215) and Tameside (189).

The rain started again and fell steadily for some time and puddles began to form on the track making spins and excursions onto the infield a common occurrence. After 3 hours Bradford had increased their lead to 21 laps over Tibshelf 'A' (404) and continued to draw steadily away until the latter stages of the race.

London, plagued with bad luck throughout the day had to drop out after 3½ hours and the final positions after 6 hours hard racing were:-

1. Bradford 827 laps (108.1 miles).
2. Tibshelf 'A' 769 laps (100.1 miles).
3. Newbridge 714 laps.
4. Tibshelf 'B' 637 laps.
5. Wombwell 595 laps.
6. Tameside 403 laps.
7. London 290 laps then retired.

The six members of the winning Bradford team were presented with their trophies by Mr. Peter Jones, the Managing Director of the events sponsors SAPA, as



were the members of Tibshelf 'A' and Newbridge. Mrs. Jones was presented with a bouquet of flowers by Miss Carol Heffer, daughter of Tibshelf's RCRC's chairman Ray Heffer.

Cheers — Race Director — Phil Maxfield.

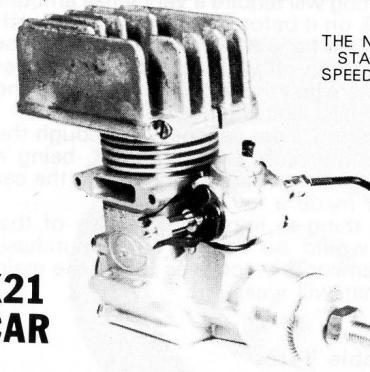

THE NAME THAT
STANDS FOR
SPEED & POWER

SUPER Tigre

X21
CAR

£44.57 (inc VAT)

Since its arrival last year the Super Tigre X21 has been the pacesetter for other manufacturers to follow. A rugged construction able to cope with the arduous conditions of competitive car racing. Just compare the specification with the opposition. An ABC piston assembly with light-weight piston, bronze bushed bigend conrod, heavy duty 12mm dia. crankshaft running in double ball bearings, specially diecast crankcase not a conversion from aircraft motor, large bore carburettor with the superb idling of all MAG series carburetors, deep finned heat sink, squish band head. BHP .75 at 25,000 rpm, weight 9¼ oz. Used by most of Europe's leading drivers.

SUPER TIGRE MOTORS ARE AVAILABLE FROM THE VERY BEST MODEL SHOPS

WORLD ENGINES

LIMITED

97 Tudor Avenue, Watford, Herts. Phone Watford 42859

Visitors by Appointment

S.A.E. with enquiries please



STOCK CAR NOTES

COMPILED BY PETER "CRASHER" CRAWLEY

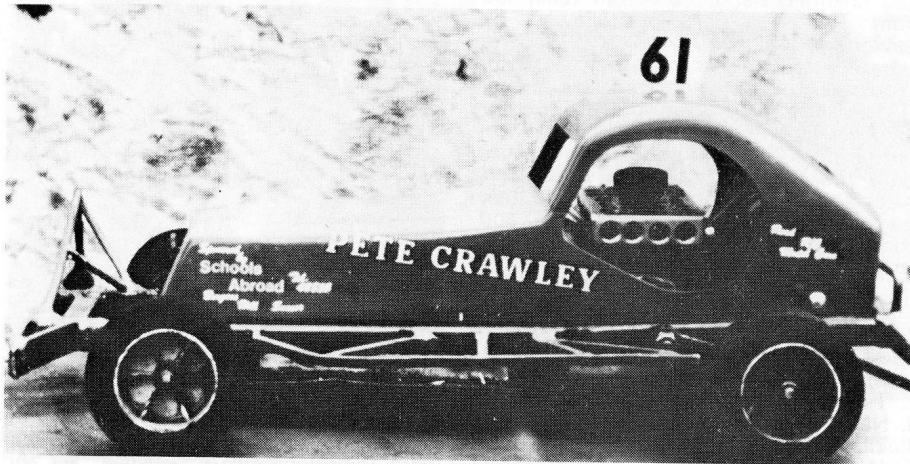

Metal Clutch Drum To Fit The Mardave Stock Car

AviCraft have come up with a very well made clutch drum to fit the Mardave clutch unit, although this clutch drum will retail at £4.85 + 15p postage as to the cost of a Mardave drum at only 80p the price is rather high, but as it is metal it should last a lot longer.

At the moment the clutch drum is still under tough tests and so a full report of its life span cannot be published at the moment.

Looking at it, it seems to be worth its money as the Mardave drum can have a short life due to the bad adjustment of the drive belt which results in the cog being worn out by the belt slipping over the cog.

Clutch drum by Avicraft to suit Mardave stock car.

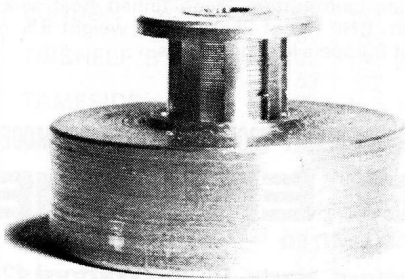

"Crasher's" own car. Bright green paint job with name in gold and red top, of course.

The clutch drum itself is steel with a brass 8th. cog and brass retaining washer, the drum will require a lining to be fitted as one is not supplied with it.

The cog will require a very small amount of work on it before installing as the teeth of the cog have a few sharp edges; these can be taken off with a small screw driver as they are just the rough edges left by the lathe whilst being made.

The drum is not very heavy although the wall of the drum is rather thick, being a metal drum the fitting of a brake to the car will be made a lot easier.

One thing to improve the sales of this drum would be if one could purchase replacement drive cogs as this is the main part that will wear out.

Inflatable Tyres

These are still in the experimental stage, but a set have been made and tested, they have been designed with the stock car in mind.

The construction is as follows, the rim is made up of three parts, the centre holds the valve with the other two parts holding the tyre in place.

The first tyres made were a wet type but due to the thinness of the wall and tread and the wrong compound they scrubbed very quickly.

The designer is now making them with a thicker wall and tread but this time with a

more resilient tyre compound to stop the quick wear out tendency of the last ones.

The idea of these tyres is to have a hard and soft tyre in one just by the use of different tyre pressures.

The cost of a rim and tyre will be in the region of £2, with replacement tyres at about £1 each.

Once these tyres have been perfected the making of slicks will not be far behind.

I will be reporting more on the progress of these tyres and also how the clutch is standing up to its tough tests in the next issue.

this is where the fastest drivers will be. Closing date for pre entries will be 24th Sept.

Sussex Open Championship

To be held at Haywards Heath of 29th October 1978 Cost £1 Pre entry only, Maximum of 36 drivers, so it's a case of first come first served, closing date 20th October. Entry form from Comp. Sec. 16 Turners Mill Rd, Haywards Heath. Sussex.

Electric Stock Cars

These are a modification of the Mardave. A model shop in Sussex is supplying these and as yet I have to find out a bit more about them as these are not covered by the R.S.C.A. rules, as the rules only mention glow type engines. I look forward to seeing an electric in competition with a glow engine stock, the only thing with electric Stock cars is can the nicads take the punishment that these stock cars take? As and when I find out more about these I will write a full report. .

World Championship 1978

To be held on 1st October 1978.

This will be held at the Mencap circuit which is 2 miles out of Leicester on the A47 (Hinckley Road) 50 yards past Western Park entrance (R/hand side out of Leicester) Drivers wishing to enter this years world champs should fill in a race entry form which will be on the R.S.C.A. news letter.

Cost of entry will be £1.00 if sent with entry form. Drivers may book in on the day but will have to pay an extra 50p.

Practice sessions will be run in the morning. Race will start at 1.00 p.m. If you not interested in racing then go and watch

Something new! Inflatable tyres on special plastic hubs for stock cars. Valve is moulded in hub and tyres are "tubeless". Historians note: Similar tyres were made for cable racing 35 years ago!

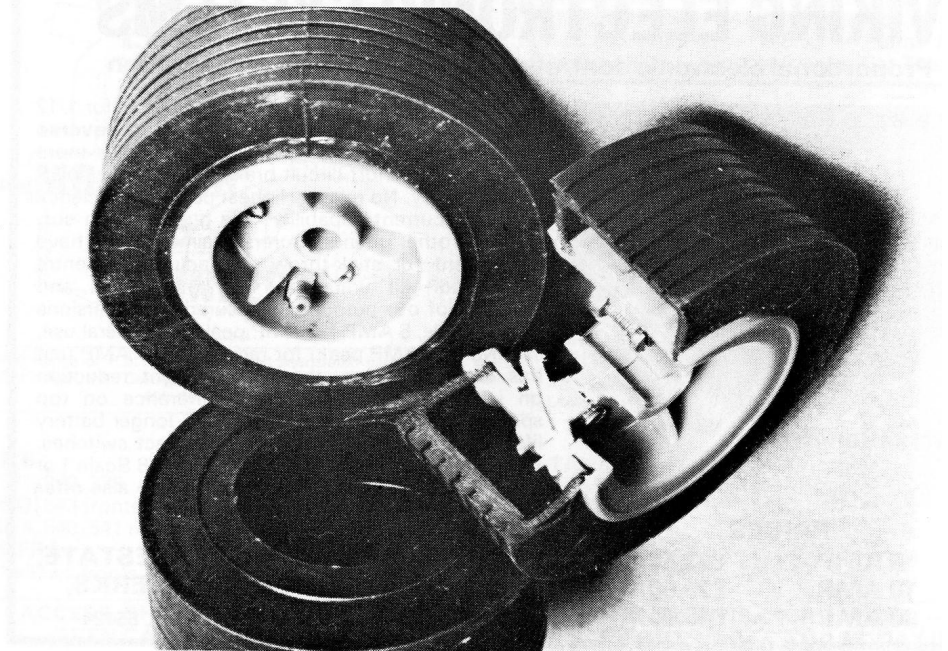

British Drivers' Championship at Brisca World Final

In the Radio Stock Car Association's last newsletter, as well as the 1978 fixture list, was included details of a special event later this year. To be called the "British Drivers' Championship", this meeting will be held at, and on the date of the BRISCA World Final i.e. Belle Vue Manchester, 23rd Sept. Trophies and other facilities will be provided by Belle Vue, and, for this reason, race entry will be free of charge, but limited to 36 entrants (R.S.C.A. members only eligible). This meeting will start in the early afternoon, and competitors will be issued with tickets for the F.I. stocks final, held in the evening. Entry to the R.S.C.A. event is via the newsletter application form only. Entry form and details from D. Wragg, 1 Bignal Drive, Leicester Forest East, Leicester.

European Stock Car Champs

This regular annual event takes place on October 15th at Stock Car Racing Holland's circuit at Rosmalen, starting at 11.0 a.m. This is a fully equipped model circuit with power, water, toilets, electronic lap counters, refreshments... in fact the lot. Competitors will drive a

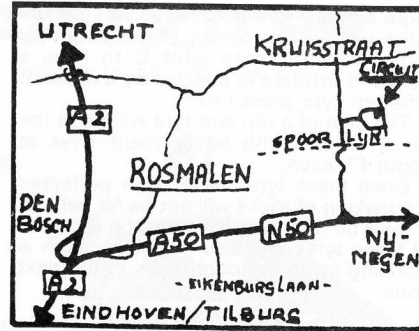

number of three minute heats, the best drivers going on then to the finals. Prizes are announced as "very beautiful"; ten handsome cups, measuring plus or minus 30cm are waiting for the ten best. All entrants will also receive souvenir awards. Entry is open both to Stock Car Racing Holland and to non-Dutch drivers at an entry fee of F1.10 (about £2.50). Details from: Frits Aalders, Eikenburglaan 2 5248 BD Rosmalen, Holland (Tel: 04192 - 3394). Rosmalen is in Brabant less than 100 miles from Hook of Holland. (See sketch map).

VIKING ELECTRONIC SYSTEMS

Proportional electronic controllers not requiring servo operation

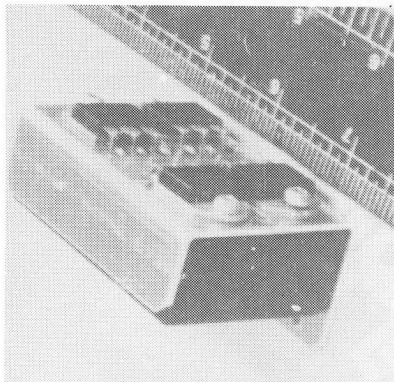

The first electronic speed controller suitable for 1/12 cars with fully proportional forward and reverse capability. Proportional reverse thrust is far more effective than short circuit braking. Complete solid-state circuitry. No relays. Highest possible efficiency and high current capability. We guarantee to surpass all other manufacturers claims. Units have adjustment for stick-throw and adjustable centre dead-band. All units are fully guaranteed and reliability of our products is assured. Two versions are available, 5 AMP (10 AMP peak) for general use, 10 AMP (20 AMP peak) for racing. The 5 AMP unit has current limiting, thus giving slight reduction on initial acceleration yet no difference on top speed, but gives a nett effect of 25% longer battery life 10 AMP unit is quicker than contact switches. Not shown here but for enthusiasts of 1/8 Scale 1 or 2 bullets, dependent on battery volts, we also offer a 30 AMP reversible controller.

PRICES

5 AMP	£23.50
10 AMP	£28.50
30 AMP	£48.50

SAE FOR FURTHER INFORMATION

113-115 LISCOMBE TRADING ESTATE,
BIRCH HILL, BRACKNELL BERKS,
ENGLAND TEL. BRACKNELL 55124

GB MODELS

WESTON-SUPER-MARE 26265 (P.M.)

9 THORBURY ROAD,
UPHILL,
WESTON-SUPER-MARE,
BS23 4YE.

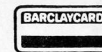

Ring Through Your Access or Barclaycard Number for Fast Mail Order Service on all R/C Car Requirements



FULL RANGE OF P.B. KITS AND ACCESSORIES IN STOCK

PB DIFFERENTIAL : NEW AIR FILTERS : GRP CHASSIS PLATES available NOW
NEW CARBS available shortly

International Kit £75 — Expert Comp £61 — Expert Std £45 — Racing Doubles £29 — MRP 1/12th Electrics from £59.95 — Mardave 1/8th £23.75 — Mardave 1/12th — Electric £37.50 — New S.G. Futura III Kit £72.00 inc. Free ABS Body — Your Choice — Full Range of Raydio & P.B. Tyres — K & B, S.T. OPS and Veco Engines

Special Purchase of 1/12' Tyres, 1 3/4" diam., 1 1/8" Bore
All Grades 32p to 40p per pair + postage

Join Woodspring Radio Auto Club and Drive at Mendip Model Racing Circuit

WE ARE DISTRIBUTORS FOR P.B. PRODUCTS AND
RAYDIO TYRES — TRADE ENQUIRIES WELCOME

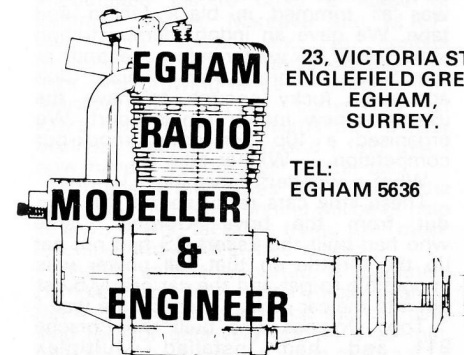

23, VICTORIA ST.,
ENGLEFIELD GREEN,
EGHAM,
SURREY.

TEL:
EGHAM 5636

Full Range of P.B. International and Associated car spares — special fuel mixed with Castrol 98 Gas Turbine Oil — Associated Disc Brake conversion for P.B. International

TYRES

P.B.	DELTA	ASSOCIATED
371, 372, 373,	340 A & B rears	832, 1223, 1225,
542, 543 fronts	316 & 315 fronts	1226 fronts
374, 540, 541 rears	ULTIMARA	2402, 2401 rears
UFRA	RSS 50 & 60	UFRA
Yellows fronts	rears	Slit & Specials rears

SPECIALS — K & B 21, P.B. Head, PERRY 61 Pumper £57 — Amps diffs, ready to go for P.B. International — £49.50 — Parma March Bodies £8.00 — Cippola Cranks, Get This 53p!!

DELTA GOODIES

Tank Quickfill Tops
Super Servo Arms
Override Kit
Sintered Fuel Filter
Servo Saver

K & B 21 & S.T. X21 SPARES

Piston & Liners
Conn Rods
Crankcases
Crankcases
Bearings (welded cage type)

P.B. HEATSINK HEADS K & B — S.T. — VECO — VECO BODIES

ABS, Lexan
Lexan Paint & Glue

VECO-McCOY SPARES

Rings
Piston & Liners
Heads
Crankcases
Rods

CARBURETTORS

Perry 61 Pumper
E.D. Car
E.D. 60 Size
Thorp Slide
Webra Slide
O.P.S. Slide
P.B. Slide?

TANKS

Johnson Metal Tanks
Associated Fillers & Pressure caps
Associated Flip Tops
Big Shot Fuel Bulbs
Sullivan Crap Traps

ACCESS, CHEQUES
EVEN CASH!

* EASY PARKING *

OPEN MONDAY-SATURDAY (9.30 — 6.00)
LATE NIGHTS MONDAY & FRIDAY (8.00)

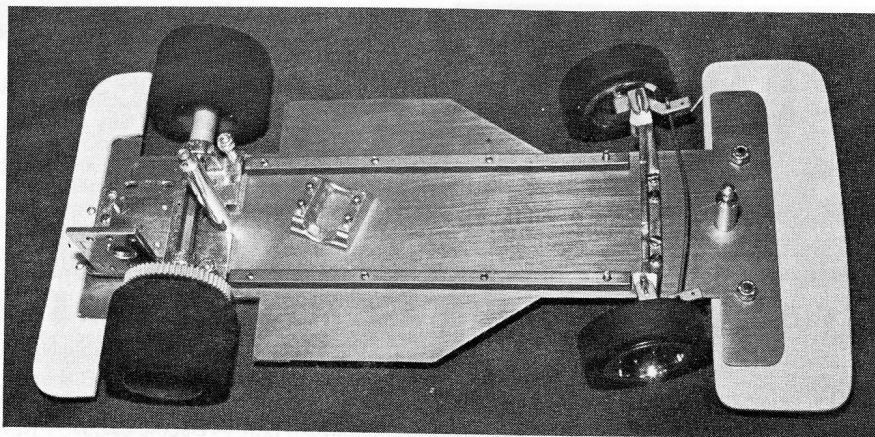

FIRST STEPS WITH ELECTRICS

A LIGHT HEARTED
INTRODUCTION
BY MIKE BOOTH

Having been a keen modeller for some 45 years and passed through most of the phases of our hobby, free flight aircraft, control line, boats, 1/32nd slot car racing and early r/c (Mercuryrossor E.C.C. Tele Commander, etc.) and over the years worked up to full house R/C aircraft with retracts, flaps and the attendant high cash outlay, then on to helicopters and the added problems of loads of gear to cart around. I had a good look at I.C. car racing but felt that this, as in 1/32, slot racing is rapidly getting a bit out of hand in terms of cost equipment and time for the "Sunday Racer". We have always had problems in this area of Blackpool with noise — fairgrounds yes — models — no way!

Several mentions and one or two write-ups in the Aircraft Magazines prompted me to try a small electric R/C car. Only one of our local Model Shops showed any interest at all in the little beasts, so, with a view to getting some racing going in this area I approached "Lectricar" direct and they were kind enough to supply three 6 CELL cars for us to try.

Two of the Blackpool Club members agreed to "have a go" with me, and we duly completed the cars, about

American Tatone chassis for 1/12th scale, can also be used for i.c., as evidenced by engine mount loose on chassis.

two or three hours on the chassis and varying times for the body finish. Mine was all trimmed in black fablon and tape. We gave an indoor demonstration at the last of our winter indoor meetings at the South Shore Lawn Tennis Club and were lucky enough to have the use of a new indoor tennis court. We organised a 10p per entry knock-out competition — Winner take all.

What a wonderful evening !!!

These little cars really sorted the men out from the boys. Gordon Clarke who had built the Escort RS had not set up the throttle so that full power was impossible to get and the car nearly burst out into the car park — through the wall!

Tony Downes who built the Porsche 911 and had installed Multiplex F.M. radio gear had the throttle set up O.K. but at re-charge time in the car-park, connected the charging leads to his car battery backwards (good beer in the Bar!) but the fizzing noise was noticed and the leads connected up correctly and after a full 20 minutes of correct charge the power pack seemed O.K. No sudden bangs but just a small fall off in running time but a procedure definitely **NOT** to be recommended.

My car, the Porsche 935 Saloon fared O.K. in the chaos but was, at one time, firmly stood on by a junior member who

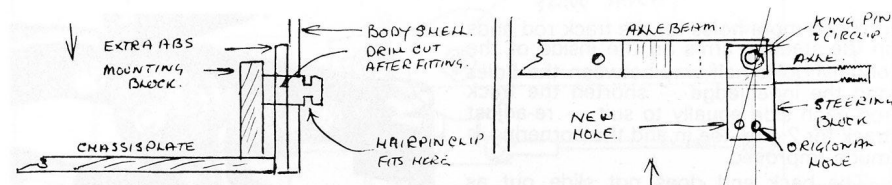

jumped to get out of the way of it but landed on the car and ended up flat on his back! Lectricars do not make very good skate boards!

The point of all this is that we have found these cars virtually indestructible and they provided a really hilarious and enjoyable evening for some 30 club members with no noise, no smell, no oil and very little cost. Our evening so impressed the Tennis Club Committee that we now have a standing invitation to use the indoor court for a series of race meetings.

Further joy was offered by our local Council to use a big, new billiards table smooth black tarmac car park for outdoor meetings.

The 1/12 electric car is quite exciting on an indoor track, but outdoors with 50 yd straights it is positively hairy and needs quite a different set-up and technique.

The interest generated locally has encouraged me to order a range of Lectricar spares, Mardave and M.R.P. cars with spares and to contact Modelcraft's to obtain supplies of their ever growing range of goodies. The Mardave and Tyrrell conversion kit looks really good. It seems that a new business has been born and I find that I now have a young tiger by the tail.

Perhaps a few notes on the Porsche 935 that I have been running will be of help to anyone who feels like trying this most exciting and trouble free racing.

The kit, as often reported, is absolutely complete and just needs Radio gear to get it running. I found that the charging lead resistor gets *very* hot on a 20 min. charge so I bolted it to a piece of 4" x 4" x 1/8 Dural which now dissipates all the heat and stays just warm. The two 6BA bolts which hold the front plate to the chassis tend to shear if the car hits a solid lump, like a kerb stone or 1/2 brick so I replaced them with two hard steel 1/8 CSK bolts with Nyloc nuts and countersunk the bottom of the plate to keep a smooth under-side to the car front. The aerial layout as shown restricts the range to about 25 yds so I drilled a hole in the off side front of the radio box and fitted a 14" length of 1/16 welding rod and connected the end of the aerial to it. This leads out of

the body at the base of the off side windscreen pillar, is bent over at the end and covered with a plastic cap from an old aircraft fuel filler. The rear body mounting studs are grooved to take the hairpin retaining clips but the body shell is just thin enough to drop into the gooves and makes the body quite tricky to get on and off so I cut two patches from the A.B.S. left over from the wheel arches and zapped them to the inside of the shell, re-drilled to size and now find that the body fits on and comes off without getting "hung up" on the stud grooves.

After 2 or 3 tank-fulls — charges or whatever of belting round the car park, the front tyres were getting very thin — torn off in fact so I checked up on the ackerman set up on the steering and found it non-existent. Perhaps O.K. for a gym or dance floor but no good at all for high speed drifts on tarmac.

The standard steering can be easily modded to give quite a good result. Just

QUICK CHECK! Ordinary model airplane prop (say 8 x 5) is pushed on electric motor and driven by car batteries. Amount of urge can be gauged after a little practice by prop speed. A useful little gadget for the toolbox.

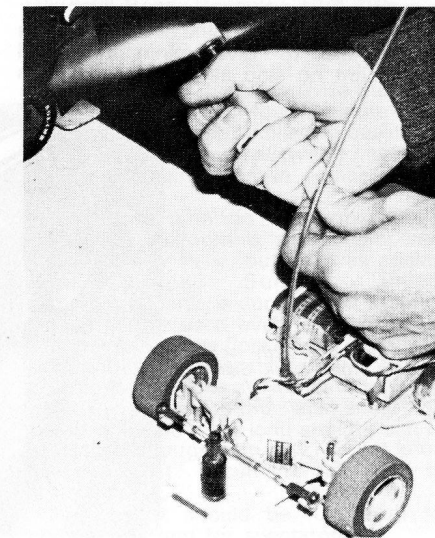

drill two more holes for the track rod ends in the steering arms on the inside of the original holes half way between the holes and the inner edge — shorten the track rod each side equally to suit — re-adjust track for 2 deg. toe in and the cornering is much improved.

The back end does not slide out as much when accelerating out of corners and the tyres do not get scrubbed off!

Front tyres as supplied are too soft and too grippy for tarmac so as my rear tyres were showing signs of wear I set a "Plasplug's" knife blade to protrude just the tyre thickness, blocked the car up, put on some power and fed the knife into the tyre at the joint line. Carefully stripping the narrowed section of tyre off the wheel, I cleaned off the old Evostik with petrol and fitted the new fronts in place of the worn out soft tyres. A new pair of rears finished the job. All tyres of equal hardness and the car will four wheel drift without spinning out and the tyres last much longer. On tarmac that is!

The radio installation could do with a few words as aircraft and helicopter linkages can be applied to the car set-up. I have used Futaba 16m Servos which have proved very adequate for the job. The useful bike spoke can be used with the threaded end screwed into a standard wide throat ISHIPLA clevis; these will fit the Futaba output discs and move full throw without jamming. The steering and throttle ends are just bent to a 90 deg angle and locked with the Lectricar retaining buttons (a blob of Zap helps here)

The steering link should be set up on the outer hole to give minimum wheel movement no slop at all! For beginners

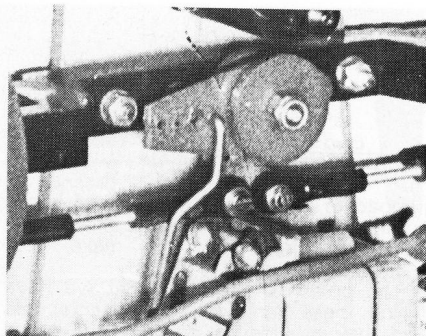

the throttle link can be arranged so that full power does not come in on full stick movement with the trim lever fully back, then as the tyro progresses the trim lever can be advanced to the full power position.

Be careful 'though on the full power these cars are very fast and not at all forgiving.

We are waiting anxiously for our first batch of Mardave cars to arrive and should Dickie and the readers want a few tips on these we will be delighted to oblige. The Red Spot motors from Modelcraft are on order but it is felt that this could be the "thin end of the wedge" to a price escalation where depth of pocket will equate with speed and winning as happened with 1/32 Slot Cars.

Perhaps the powers that be will foresee this danger and formulate rules which will keep competition keen and the price down.

Good racing and if you try your car out on the road (we all do) don't get nicked for speeding.

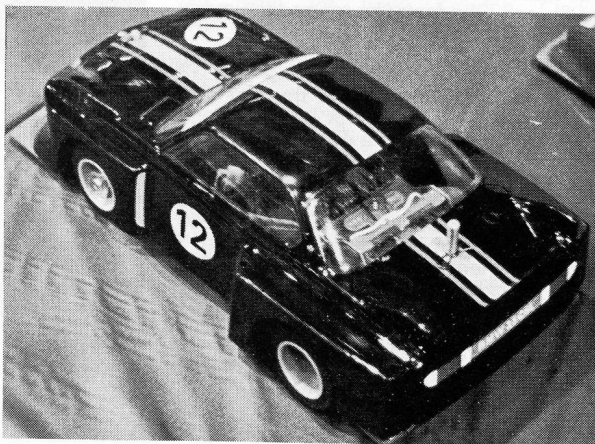

Pro Series 1/12th scale electric from Weak Signals Show. Car is BMW, also available is Ferrari 512BB.

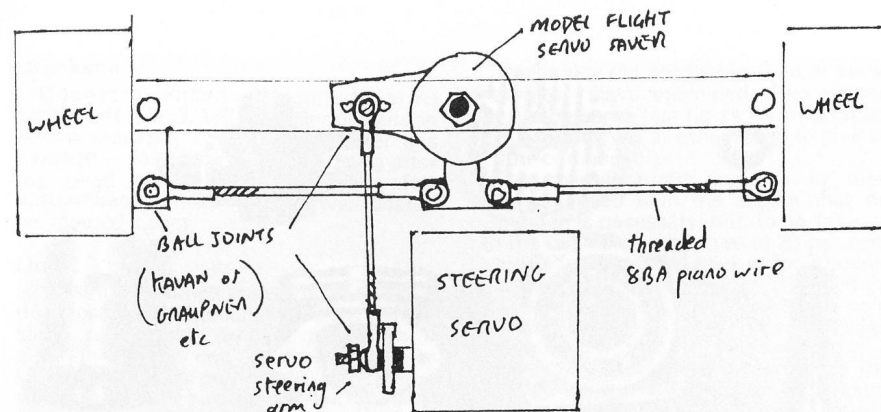

MORE ELECTRICS...

Servo-saver

Here is another one from that regular source of inspiration the *Ally Pally* Newsletter, a servo-saver for a Mardave which overcomes problems with the original coming apart. It is based on the Model Flight servo-saver and is easy to fit. Sketch and photo should make all plain. It is available with either strong or weak springs but the packet does not say which!

Electrics in Maidenhead

A pilot run of meetings has been held fortnightly in Maidenhead throughout the summer. As from mid-August they will be held weekly mostly on Saturday evenings. A few Sundays have to be accepted due to the venue being a sports hall. The whole idea is being vaguely run by Maidenhead Radio Models from whom a list of dates and general information can be obtained if a stamped addressed envelope is sent. It is hoped that a properly constituted electric only club will be formed at the earliest opportunity. That is to say, as soon as someone can be persuaded to do the necessary secretarial and organisation work! What! No car! MRM will soon put that right! For those who do not read the ads. address enquiries to Mr Roy Price, Maidenhead Radio Models, 55 Queen Street, Maidenhead, SL6 1LT.

Electrics at Pontins

Sunday October 8th is the date for Pontins 1/12th Electric Car Championships to be held in the Main Ballroom at Brean Sands Holiday Village during their 2nd National Model Makers' Festival Week. Practice sessions are available from 2.0 p.m. to 6.0 p.m. on Saturday 7th and from 9.0 a.m. to 11.0 a.m. on Sunday morning the 8th. There will be Concours d'Elegance

for cars taking part before racing starts. Individual and team entries will be accepted. A team will consist of three members all running identical cars, i.e. same mechanics, body and livery. Team members also eligible for individual prizes. Maximum entries 60. Entry fee £1.50 individual; £5.00 team. Cheques to be made payable to pontins Ltd.

Prizes: Individual, presented by Pontins, 1st Trophy, plus £50 Pontins Voucher, 2nd Cup plus £25 Pontins Voucher, 3rd Plaque, plus £10 Pontins Voucher. Concours: 1st, 2nd, 3rd, Trophy, Cup and Plaque presented by Modelcraft. Team: Trophy presented by Bic (the pen people of course). Entry Form and rules from organising official: Tony Devenport, 200 Windmill Road, Coventry, CV6 7BE.

Construction rules are very much as normally run, except that aerofoils where fitted to saloon cars must be below roof line. Racing rules include proviso that each driver will take part in four 5 minute heats the best *three* being totalled to qualify for final. Teams will count *all twelve heats* (i.e. four from each driver) in competing for team prize.

For those who do not know Brean Sands the ballroom is small, compared, say, with Ally Pally, but large as against Countesthorpe. Surface, unless something drastic is done to it is slippery. It is of course used every evening in the summer as a dance floor. Tyres and set-up should therefore bear this in mind. Size of course is more likely to favour easily manoeuvrable cars rather than sheer high speed, since no really long straight can be envisaged, though, naturally I do not know exactly what circuit layout will be arranged.

Anyway, it should be fun, both for competitors and for spectators.

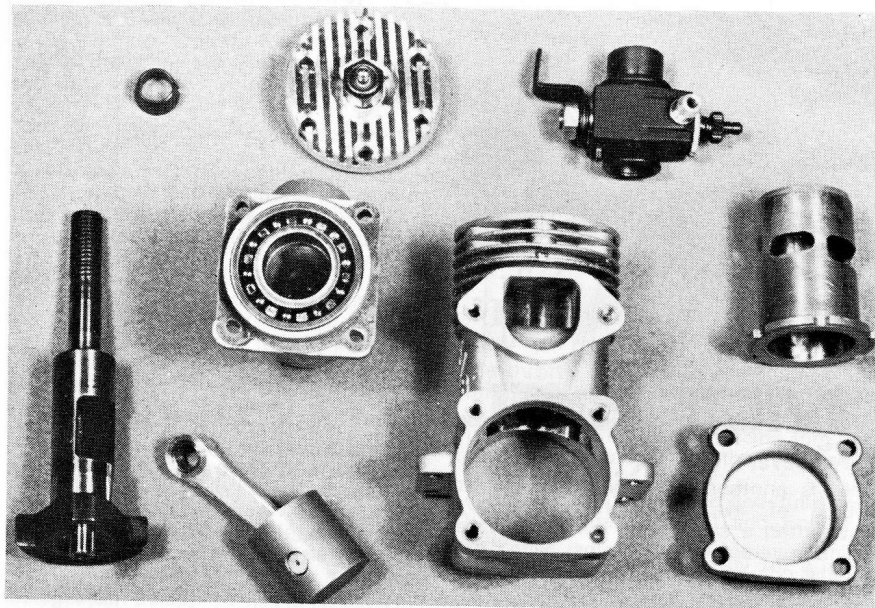

K&B 3.5cc ENGINE TEST

CONDUCTED BY FRED LIVESEY

THE 'out of the box' K & B 3.5cc engine is without doubt the most powerful engine used in model cars. The engine has been around for over 12 months now and a brief history does not seem amiss.

The original examples suffered from a flaw in the connecting rod forgings which allowed the little end to become detached from the conn rod with disastrous results. The consequential damage needed the replacement of piston and liner, conn rod and usually crankcase — because of the large hole!

The crankcase castings appeared to be made from a rather brittle aluminium alloy, and I've seen cases with broken mounting lugs and cracks. How much this is due to the separate front housing isn't plain but most competitors these days glue the front housing in with epoxy or lock-tite.

It's a credit to K & B that as soon as faults were brought to their notice they produced a far better crankcase casting and replaced the connecting rod forging on their later examples.

The front housings still need glueing in — I wonder if this is due to the enormous

overhang of flywheel and clutch assembly — and the gears being forced apart by the power.

Bearings have given the same problems as with other powerful engines and are usually replaced by a bearing with a spot welded cage.

If you consider that the engines we use revolve approx. 650 times per second then it is amazing that any of them stay together. The engine has probably been used by more successful competitors than any other and has certainly been responsible for some of the increase in speed this year.

I hope you will forgive a rather longer than usual introduction — but I felt it was relevant. Now to the gritty bit.

Engine Type

3.5cc Schnuerle ported A.B.C. (Alloy piston running in a chromed brass liner) rear exhaust front induction engine. Whew!

Bore 0.650 (16.51 mm) — Stroke 0.640 (16.256) — Displacement 0.2124cu.in (3.481 cc)

Crankcase

Die-cast aluminium alloy crankcase with separate front housing and backplate held with socket cap screws — 24 mm OD x 12mm bore, Rear bearing with brass cage — 5/8" OD x 1/4" Bore shielded front bearing.

Crankshaft

Counterbalanced hardened steel crankshaft with 3/16" diameter pressed-in hollow crankpin — 11/32" diameter gas passage — inlet timing opens 40 deg after top dead centre closes 52 deg after bottom dead centre — prop driver located by tapered collet.

Liner

Separate chromed brass liner with a wall thickness of 0.045 located by a top flange. Large rectangular exhaust port with a duration of 152 deg — K & B's own schnurled transfer port system each with a separate transfer passage in the crankcase — with two side angled ports and two steeply upward angled ports facing the exhaust port — all opening simultaneously with a duration of 124 deg.

Piston

Die cast aluminium alloy — gudgeon pin hole drill in one side only — 5/32" diameter hollow gudgeon pin with PTFE end pad, which is located by bridge between transfer passage in the liner.

Connecting Rod

Aluminium alloy forging — phosphor-bronze bushed big-end — oil holes drilled in big and little ends.

Cylinder Head

Finned aluminium alloy combustion chamber 1/8" (3mm) wide squish band — fitted with short reach glow plug. As most competitors will be replacing this cylinder head by one of the heat sink variety — this is the type used for the test.

Carburettor

Perry Micro carb held in by two slotted grub screws — 11/32" diameter spigot in front housing — 0.200" (5.1mm) bore spray tube intrudes into ventury 2mm long x 2mm wide, giving a cross sectional area of 16.43 sq.mm.

Weight

Less silencer — 7.0 oz (198.5 grams)

Distributors

Irvine Engines

Performance

The engine received for test was the No8380 "Plane and car with silencer" but as car competitors are using the dust-bin type silencer I felt it better not to use the silencer provided.

The engine did not feel so tight as some examples I have examined. Test carried out on the same test rig as last month, as — it is hoped, will all other tests, to give us a true comparison.

The manufacturers indicate in their leaflet supplied with the engine that no running in is necessary, but, to be fair — I ran the engine on a mixture of 30 per cent Castor, 70 per cent Methanol for 30 mins. to allow bearings to bed in. The mixture was then changed to the usual 15 per cent nitromethane, 20 per cent castor oil 65 per cent methanol mix for the test.

The engine started very easily with the electric starter and after initial adjustment ticked over steadily at 3000 RPM. Taking readings on the test rig indicated the excellent torque this engine puts out with a maximum figure of 38oz inches at 12000 revs. The maximum power is developed at 21,000 revs per minute giving 0.65 BHP (Brake Horse Power).

Conclusions

The test carried out with an engine basically straight from the box and fitted with (by today's standard) — a small bore carburettor, indicates the reasons for it taking most of the laurels since its introduction. Most competitors nowadays fit either Perry 60, Pumper 61, or large bore P.B. carburettors — and it would be interesting to do a further test on this engine when the new P.B. carb is available. (Buy British!)

Heatsink heads are available from various manufacturers and most car kit manufacturers supply clutch assemblies so no difficulties should be found when fitting to a car.

Already various engine modifications are available. McCoy supply liners and pistons with a really beefy con. rod and various con. rods are available from America. So far as I'm aware the improved K & B rod stands up to it these days.

Probably the best way to buy this engine for the model car enthusiast (or should I say fanatic — we must be mad!) is in the 'Free flight' plane version — less silencer.

These are available now from the usual sources, fit the carburettor of your choice — various competitors have their own view, mine is in favour of P.B. (no connection etc).

Well, if you want the fastest, out of the box — this is the one to buy. A recent letter in Model Cars indicated that the writer disagreed with the view "that it was not a beginners' engine" well — I feel that it can be a bit of a handful when beginning the sport.

MRM FOR CARS

"GLASS CHASSIS AREN'T A LOT OF BOTTLE"*

Sorry folks, but we couldn't resist the pun. But now we have your attention ... read on ...

IN STOCK NOW ...

PB6 International SG Mardave
PB7 Export Jerobee Pilot
PB Junior Tamiya XR 311 (unbelievable)
Assoc RC 100 and 2 Plus rest of R/C Range

Edai Porsche 935 1/2 electric engines include ... ST X21.
OPS 21, Fuji 19 BB, Cipolla 21, Irvine 20 (car).
New! Webra 20 RCA (car) New! 0521 FSR (car)
KB 21 H/Sinked, manifold, pumpered and filtered for under £60

Sullivan Starters Crap Trap Filter
Fuel Bulbs MRM Flip Top Tanks, sumped £7.50
*Epoxy Glass Chassis 1/2 £8.00 — 1/12 £2.50
Smoothtronic speed controllers plus voltage regulator to eliminate RX Nicad

AMPS DIFF. £49.95 P.B. DIFF. £28.00

Rapid charge Nicads .45A thru to 7A
FREE PARKING OUTSIDE CLOSED THURSDAYS

All enquiries must have a S.A.E.

MAIDENHEAD RADIO MODELS
55 QUEEN STREET, MAIDENHEAD,
BERKSHIRE. TEL. 37295

THE MODEL AIR-PORT FILTON BRISTOL

R/C CARS
ENGINES
RADIO

MAIL ORDER
ACCESS
BARCLAYCARD
HOBBYCARD

EXIT 16 — M5 Five Minutes
Closed Wednesday

134 GLOUCESTER ROAD NORTH
FILTON, BRISTOL TEL: 694541

MICHAEL'S MODELS

646-648 High Road,
N. Finchley, N12 0NL

Telephone: 01-445-6531

CAR KITS by Mardave, P.B., Ke'Jon,
Lectricar.

ENGINES by Super Tigre, O.P.S., K&B,
Veco, Enya.

P.B. International Kit **£75.00**

K&B 21 R/C **£47.50**

P.B. Heatsink head for K&B, Veco **£7.50**

Lectricar with proportional speed control,
Porsche 911, Escort, Porsche 936 **£44.87**

Full range of spares. Send S.A.E. for list of
Kits, Engines.

Phone your Credit Card Number for same
day service. Access, Barclaycard, Carte
Bleu, Eurocard, Mastercharge, Visa, Bank
America Card



Isn't the Best worth just a few more Quid, Marks, Gulden, francs, Dollars, Lira, etc???

Thinking Electric Think Bo Link!!

Available in Europe
Write for name of nearest distributor
Catalogue available: Send £1 for postage

Bo Link Industries
Box 80653 — ATALANTA,
GEORGIA 30366 U.S.A.

HOBBY WORLD

WE STOCK THE BEST CAR KITS,
RADIOS, ENGINES AND
ACCESSORIES FOR R/C CARS

3 YUEN NGAI ST. KOWLOON HONG KONG

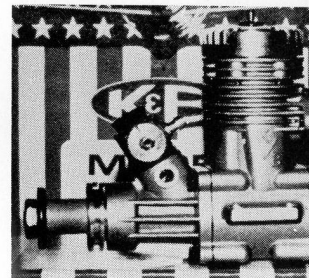

K & B 21

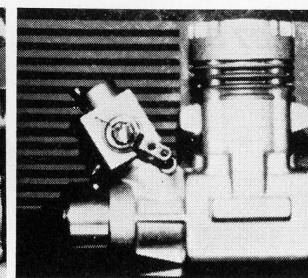

HGK 21 SF R/C

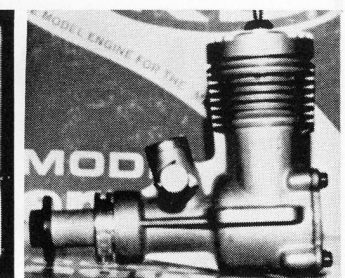

VECO 19

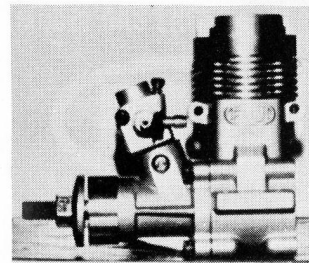

FUJI 21

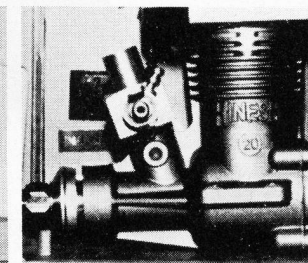

HINESS 20BB

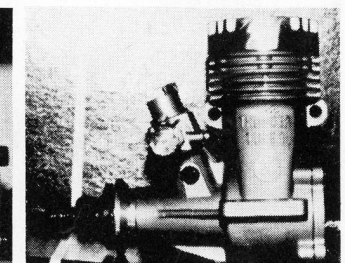

THUNDER TIGER

ENGINES		CAR KITS		SOLE DISTRIBUTOR:	
K & B 21	£40.00	AKS 78 special	£70.00	SUPER ENAMEL — 70p	
K & B 21 McCoy	£53.50	Associated RC100	£80.00	specially for clear LEXAN	
Veco 19	£20.00	Associated RC200	£100.00	and BUTRATE bodies.	
Veco 19 RC	£23.00	Challenger	£75.00	Z.90.6 LUBRICANT — 65p	
Veco 19 McCoy	£40.00	Delta JL770	£80.00	excellent for bearings	
Veco 21 McCoy	£40.00	Izumi	£68.00	and bushes.	
Ops 21	£39.50	Marker	£115.00	SIMICHROME POLISH —	
Supertigre X21	£44.50	MRP	£72.00	£2.00 Clean and chrome	
Webra 20	£42.00	Super Dash	£65.00	all kinds of metal.	
HGK 21	£33.00				
Hiness 20	£32.50	ACCESSORIES & PARTS AVAILABLE			
Fuji 21	£25.50	AKS — Associated — Delta — Globee — McCoy — MRP			
Enya X19	£30.00	Perry — RPM — Tatone			
Thunder Tiger	£10.00	RADIO — Futaba — Logita — Sanwa — K.O.			

TRADE INVITED MAIL ORDER ACCEPTED

奇趣屋



INTERNATIONAL

PB7 Basic Pack

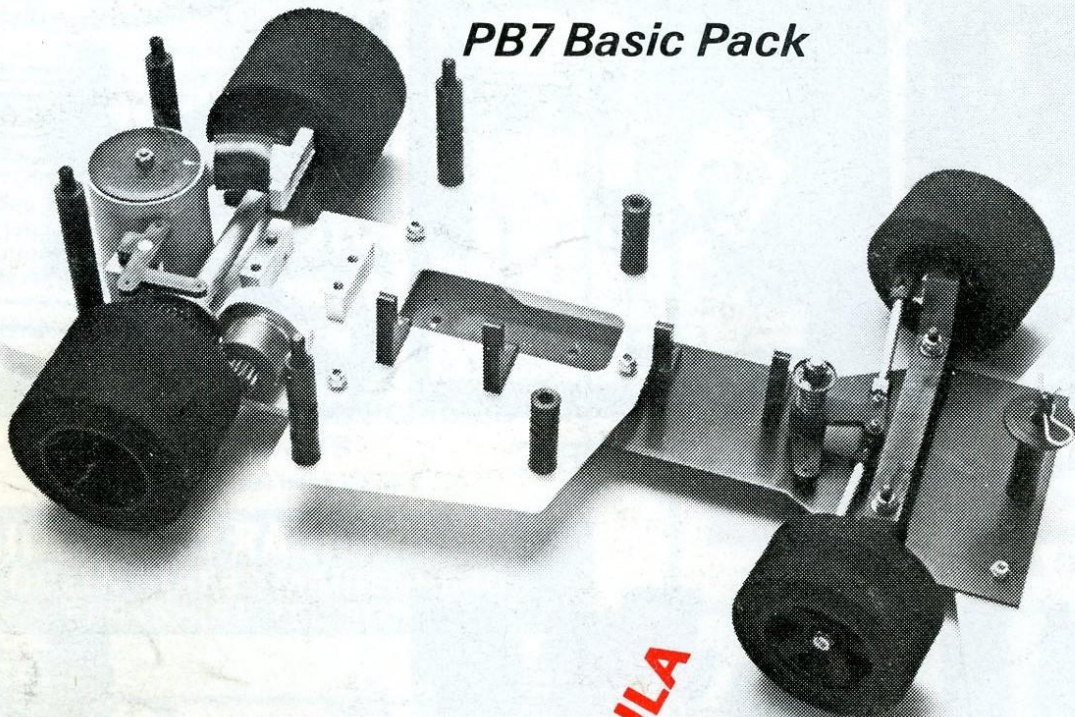

"LET IT SPEAK FOR ITSELF"

1st PLACES IN 1978

Coupe Du Monde — Monaco
 Italian G.P. — Modena
 French G.P. — Toulon
 German G.P. — Friederichshafen
 British G.P. — Lilford
 Welsh G.P. — Wrexham
 Swiss G.P. — Geneva
 British National Champs. — Wombwell
 South of England Champs. — Mendip

National Opening Meeting — Wombwell
 National Open Meeting — Bournemouth
 National Open Meeting — Bradford
 National Open Meeting — Tibshelf
 National Open Meeting — Newbridge
 National Open Meeting — Catfoss

 New 24hr World Endurance Record
 New 500 mile WORLD distance record

PB7 (Illustrated) Basic Kit **£66.10**
 PB6 With two chassis, two bodies, two wings, two bumpers and fuel tank. **£75.00**

NEW ITEMS

Part No. 550 Differential rear axle complete with enlarged disc brake and bearing blocks — truly race proven **£28.00**
 Part No. 555 New flip top 125cc fuel tank **£4.50**
 Part No. 565 New shielded air filter complete with universal adaptor sleeve and spare element **£2.75**

P.B. Products, Downley Road, Havant, Hants. Tel: (0705 471774)

1st PLACE FORMULA GT CHAMPIONSHIPS 1978